

Hoffmann® 3

Modular External Fixation

Operative technique

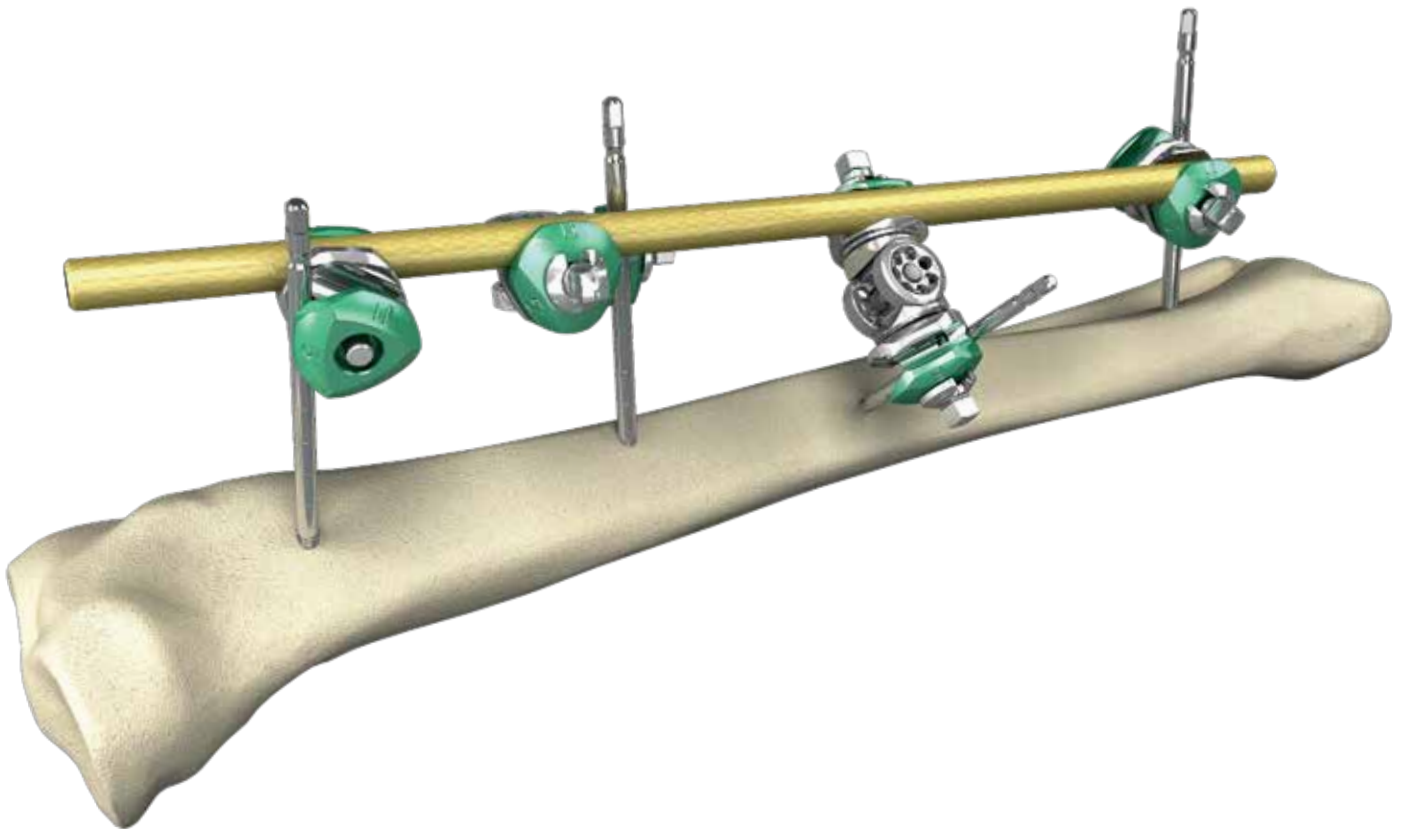

Hoffmann 3 External Fixation

Contents

Indications and contraindications	4
Technical details & MRI Information	5
Components	7
Tibial frames	15
Ankle frames	21
Femur frames	24
Knee frames	26
Pelvic frames	30
Hoffmann 3 Kits for military or disaster recovery use	34
Sterile field kit A	35
Sterile field kit A frame examples	39
Sterile field kit B	40
Sterile field kit B frame examples	44

This publication sets forth detailed recommended procedures for using Stryker devices and instruments. It offers guidance that you should heed, but, as with any such technical guide, each surgeon must consider the particular needs of each patient and make appropriate adjustments when and as required.

 **WARNING**

- Follow the instructions provided in our cleaning and sterilization guide (OT-RG-1).
- All non-sterile devices must be cleaned and sterilized before use.

 **WARNING**

Multi-component instruments must be disassembled for cleaning. Please refer to the corresponding assembly / disassembly instructions.

Please remember that the compatibility of different product systems has not been tested unless specified otherwise in the product labeling.

Consult Instructions for Use (www.ifu.stryker.com) for a complete list of potential adverse effects and adverse events, contraindications, warnings and precautions.

The surgeon must advise patients of surgical risks, and make them aware of adverse effects and alternative treatments.

 **WARNING**

- The patient should be advised that the device cannot and does not replicate a normal healthy bone, that the device can break or become damaged as a result of strenuous activity or trauma and that the device has a finite expected service life.
- Removal or revision of the device may be required sometime in the future due to medical reasons.

 **CAUTION**

The surgeon must discuss all relevant risks, including the finite lifetime of the device, with the patient, when necessary.

Indications and Contraindications

Indications

The Hoffmann 3 Modular External Fixation System Components are external fixation frame components for use with the components of the Hoffmann II MRI and Hoffmann II Compact MRI External Fixation Systems, in conjunction with Apex pins. It is intended to provide stabilization of open and / or unstable fractures and where soft tissue precludes the use of other fracture treatments such as IM nailing or casting or other means of internal fixation.

The indications for use of external fixation devices include:

- Bone fracture fixation
- Osteotomy
- Arthrodesis
- Correction of deformity
- Revision procedure where other treatments or devices have been unsuccessful
- Bone reconstruction procedures

Contraindications

Since external fixation devices are often used in emergency situations to treat patients with acute injuries, there are no absolute contraindications for use. The surgeon's education, training and professional judgment must be relied upon to choose the most appropriate device and treatment for each individual patient. Whenever possible, the device chosen should be of a type indicated for the fracture being treated and/or for the procedure being utilized.

Conditions presenting an increased risk of failure include:

- Insufficient quantity or quality of bone which would inhibit appropriate fixation of the device.
- Compromised vascularity that would inhibit adequate blood supply to the fracture or operative site.
- Previous history of infections.
- Any neuromuscular deficit which could interfere with the patient's ability to limit weight bearing.
- Any neuromuscular deficit which places an unusually heavy load on the device during the healing period.
- Malignancy in the fracture area.
- Mental, physical or neurological conditions which may impair the patient's ability to cooperate with the postoperative regimen.

*** Based upon Biomechanical Lab Report:
BML 11-066, Stryker in Selzach, Switzerland
BML 11-270, BML 12-061, BML 12-062**

Technical details

MRI information



Hoffmann 3 Modular External Fixation devices are labeled MR conditional according to the terminology specified in ASTM F2503, standard practice for marking medical devices and other items for safety in the magnetic resonance environment.

Non-clinical testing* has demonstrated that the Hoffmann 3 Modular External Fixation System is MR conditional.

A patient with a Hoffmann 3 Modular External Fixation Frame may be safely scanned under the following conditions:

- Static magnetic field of 1.5 Tesla ONLY
- Spatial magnetic field gradient 900 gauss/cm (90mT/cm) or less
- Maximum MR system reported whole body averaged specific absorption rate (sar) of 2 w/kg for 15 minutes of scanning time under normal operating mode
- The Hoffmann 3 system must be outside the MRI scanner bore. (See diagram for example).

Under such conditions, the maximal expected temperature rise is less than 6°C.

NOTICE

In non-clinical testing, all Hoffmann 3 Modular External Fixation frame configurations shown in this operative technique have been tested under the above mentioned conditions.

The MR field conditions should be compared with those of the user's MR system, to determine if the Hoffmann 3 device can be safely brought into the user's MR environment. All components of Hoffmann 3 frames must be identified as MR conditional prior to being placed in or near an MR environment. Because higher in

vivo heating cannot be excluded, close patient monitoring and communication with the patient during the scan is required. Immediately abort the scan if the patient reports burning sensation or pain.

CAUTION

Frames using one or more MR unsafe components should not be used in the MR Environment.

To minimize heating, the SAR should be as low as possible, and the scan time should be as short as possible. The Hoffmann 3 devices must be placed outside of the magnet bore for all scans. Under no circumstance must the Hoffmann 3 be exposed to the RF field of the body coil or the RF field on a RF transmitting local coil. Please refer to the pictorial representation on the next page showing the allowable position of the Hoffmann 3 frames in the MR scanner environment. All tested frames are safe with respect to displacement in MRI magnetic field of 1.5 Tesla only and a spatial magnetic field gradient of up to 90mT/cm.

CAUTION

MR conditional information: Compression /Distraction Tube should be used OUT OF BODY COIL.

Patient safety

MRI for patients with Hoffmann 3 External Fixation System can only be performed under these parameters. Using other parameters could result in serious injury to the patient. Use of Hoffmann 3 with other Hoffmann systems has not been tested in the MR environment and therefore there may be a risk of higher heating and serious injury to the patient. Do not place any RF transmitting coils over the Hoffmann 3 External Fixation Frame.

CAUTION

Frame tests have been performed in areas where the greatest temperature increase is expected with commonly used frames. Due to the versatility of the system, an unlimited number of frames can be built which makes it impossible to test each and every construct. Based on the test results, the Hoffmann 3 may be used in MRI procedures under the specified conditions. There are factors that can influence these results like the number of pins used in the clamps and the number of open and closed loops in the frame. Therefore, it is recommended that each frame be evaluated by a radiologist or MR scientist before the MRI procedure to ensure patient safety. Since different frame configurations and frame sizes might lead to higher temperature increases, Stryker recommends for patient's safety to minimize SAR settings as much as possible. Non-clinical testing has been performed to rule out the possibility of component movement or migration at static magnetic field strengths higher than 3.0 Tesla or maximum spatial gradients higher than 90.0 mT/cm. MR image quality may be compromised if the area of interest is in the exact same area as or approx. 10cm under worst case conditions to the position of the frame or its individual components.

CAUTION

Tests have been performed using a MR system for a max. image time of 15 minutes. Please note that the Specific Absorption Rate (SAR) may be reported differently, e.g. as whole body averaged SAR or as partial SAR by the software depending on the MR system used.

Technical details

Artifact information

MR image quality may be compromised if the area of interest is close to the Hoffmann 3 Frame components. It may be necessary to optimize MR imaging parameters to compensate for the presence of the fixation frame.

Representative Hoffmann 3 components have been evaluated in the MRI chamber according to ASTM F2119 and worst-case artifacts will extend approximately 10cm from the device for the following sequences:

- Gradient echo sequence:
TR 100ms, TE 15ms, flip angle 30°, Resolution 1 x 1 x 3mm 3, scan matrix 256 x 256, bandwidth per pixel 125Hz
- Spin echo sequence:
TR 500ms, TE 20ms, flip angle 70°, resolution 1 x 1 x 3mm 3, scan matrix 256 x 256, bandwidth per pixel 125Hz

Position of Hoffmann 3 frames in the MR environment: Entire construct should be visible outside the magnet bore

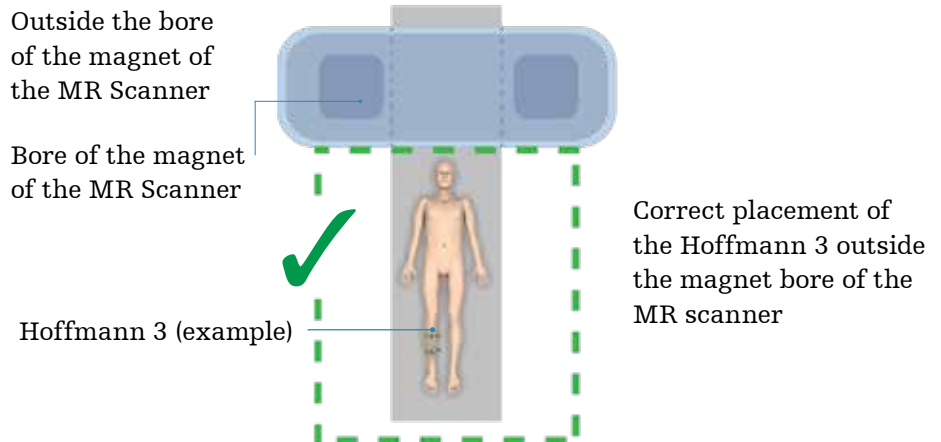

Incorrect placement of the Hoffmann 3 in the MR environment:

Partially in the magnet bore of the MR scanner

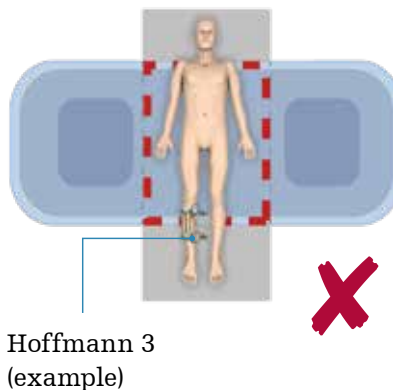

Do not use the Hoffmann 3 partially in the magnet bore of the MR scanner

Completely within the magnet bore of the MR scanner

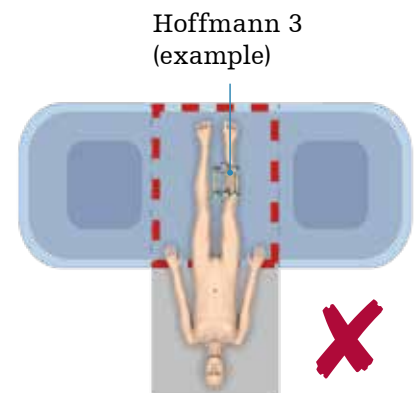

Do not use the Hoffmann 3 in the magnet bore of the MR scanner

Components

Delta couplings

Delta coupling, rod-to-rod

The rod-to-rod delta couplings can snap onto Ø5, Ø8 or Ø11mm connecting rods and Ø5mm Apex pins**. Rod-to-rod delta couplings are color coded green / green.



Delta coupling, pin-to-rod

The pin-to-rod delta couplings are designed to fit Ø5, Ø8 or Ø11mm connecting rods and Ø4, Ø5 or Ø6mm Apex pins. Pin-to-rod delta couplings are color coded grey / green.

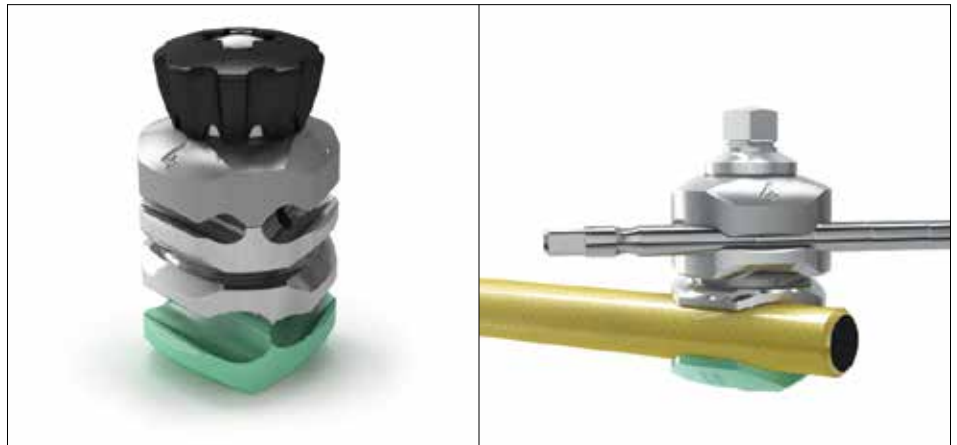

Delta coupling, pin-to-rod, inverted

'Inverted' pin-to-rod delta coupling are available with the bolt on the opposite side. 'Inverted' pin-to-rod delta couplings are color coded green / grey.



NOTICE

Standardization with one coupling may be achieved by utilizing a rod-to-rod delta coupling with Ø8mm or Ø11mm connecting rod and 5mm apex pins or 3 / 5mm, 4 / 5mm hybrid Apex pins.

Components

Delta couplings

Delta coupling, rod-to-rod, multiplanar

The multiplanar rod-to-rod delta coupling is designed to snap onto Ø5, Ø8 or Ø11mm connecting rods and/or Ø5mm Apex pins on each side of the joint.

The multiplanar joint allows for 180° of motion and 360° of rotation. Multiplanar delta couplings are color coded green/green and include two pre-assembled thumbwheels for provisional tightening.



Delta coupling, pin-to-rod, multiplanar

The multiplanar pin-to-rod delta coupling is designed to snap onto Ø5, Ø8 or Ø11mm connecting rods and Ø4, Ø5 or Ø6mm Apex pins on each side of the joint.

The multiplanar joint allows for 180° of motion and 360° of rotation. Multiplanar delta couplings, pin-to-rod are color coded grey/green and include two pre-assembled thumbwheels for provisional tightening.



Multiplanar delta couplings can be tightened on one side while keeping full rotational flexibility and adjustability on the other side.

The distance between the bars or pins can be varied from 0mm to 37mm.

Components

Provisional tightening

Step 1

Snap two rods (or a pin and a rod) into a delta coupling.

Step 2

Provisionally tighten the coupling to the rods using the thumbwheel.



Step 1

Step 2

Step 3

Remove the thumbwheel from the delta coupling before the final tightening.

Final Tightening

For final tightening use either the T-handle (4920-9-030) or 7mm spanner wrench (4920-9-036).



Step 3



Components

5-Hole pin clamp

5-Hole pin clamps can be used if parallel pin placement is desired. The clamp can hold up to five Apex half pins, accommodating Ø4, Ø5 or Ø6mm pins.

- Pin clamps are secured to the Apex pins by tightening the 7mm square head screws on the side of the clamp

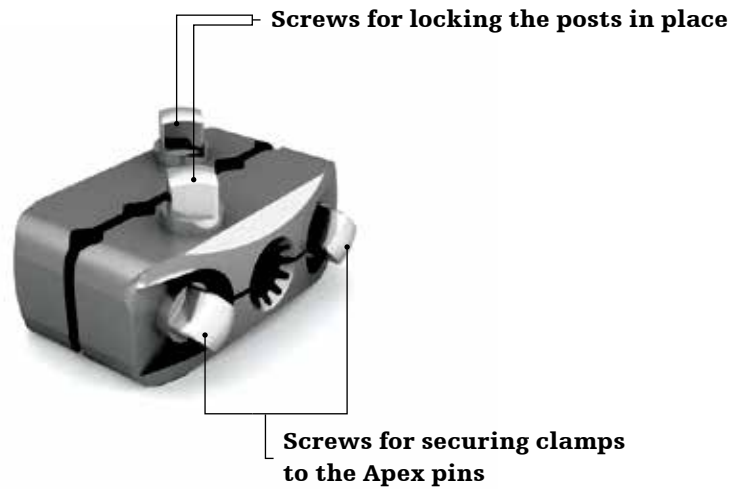

Posts

Straight, 30° or 90° angled Ø11mm posts are used along with the pin clamps to provide a compact, fracture-specific frame.

- Posts are locked into place by tightening the two 7mm square head screws on the top of the clamp



NOTICE

Tightening of the nuts for locking the posts without any posts in the hole can deform the 5 hole pin clamps and therefore limit its functionality.

Components

Fixed post clamps

5-Hole pin clamps with either one or two straight or 30° angled fixed posts are included in the Hoffmann 3 system for multiple ready-to-use configurations that don't require assembly.



Ø11mm Connecting rods

Electrically insulated vectran coated carbon fiber rods are provided for MR conditional use in 1.5 tesla systems according to the specified conditions.

The Ø11mm vectran coated carbon fiber connecting rods are available in lengths from 100mm to 650mm. The Ø11mm vectran coated semicircular rod is available in 220mm size, and may be used for the fixation of distal femur or proximal tibia fragments. Carbon fiber rods are designated as single use. Tests have shown intended performance for 50 re-sterilization cycles.*

A variety of Ø8mm and Ø5mm vectran coated carbon fiber rods are available in the Hoffmann II MRI and Hoffmann II MRI Compact system and are compatible with Hoffmann 3.



NOTICE

Testing has demonstrated intended performance of the carbon fiber rods for 50 re-sterilization cycles.*

CAUTION

All Vectran Coated Carbon Connecting rods are intended for single patient use only. Once used on a patient they have to be disposed of.

CAUTION

All Hoffmann II MRI components are mechanically compatible with the Hoffmann 3 Couplings. However, only the frames shown in this Operative Technique have been tested for MR environment.

* Biomechanical Test Reports: BML 11-059, BML 12-054

Components

Rod coupler, 30°

Rod Couplers connect two, 11mm connecting rods at a fixed 30° angle in a symmetric or asymmetric orientation and are used in building spanning frames such as knee bridging and pelvis. The asymmetric capability allows the coupler to aid in fracture reduction and is designed for fine tuning of rod length to more closely match patient anatomy. The coupler is designed with a window that allows for visual control of rod depth in the clamping area.

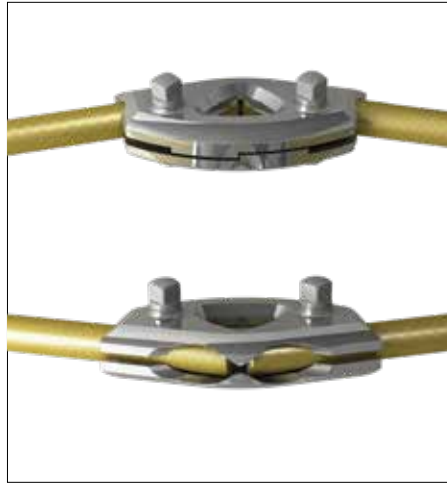

Components

Apex pin

Four types of half pins are offered in the system: blunt / self-tapping half pins, blunt / cancellous half pins, self-drilling / self-tapping half pins, and self-drilling transfixing pins. Pre-drilling is necessary when using blunt pins. It is optional to pre-drill when using self-drilling pins.

General guidelines for pre-drilling

- Always pre-drill with a new, sharp drill
- Drill slowly to help prevent thermal injury
- When placed through an exposed bone surface irrigating the interface can reduce heating
- Always use the appropriate sized drill bit based on pin diameter.

Additional options

- Stainless steel with HA coated options
- Titanium
- Sterile and non sterile packaging
- Hybrid Apex pins with 3mm thread diameter and 5mm shaft, as well as 4mm thread diameter and 5mm shaft

NOTICE

For additional information please refer to the Apex Pin Operative Technique. Content ID: APEX-ST-1.

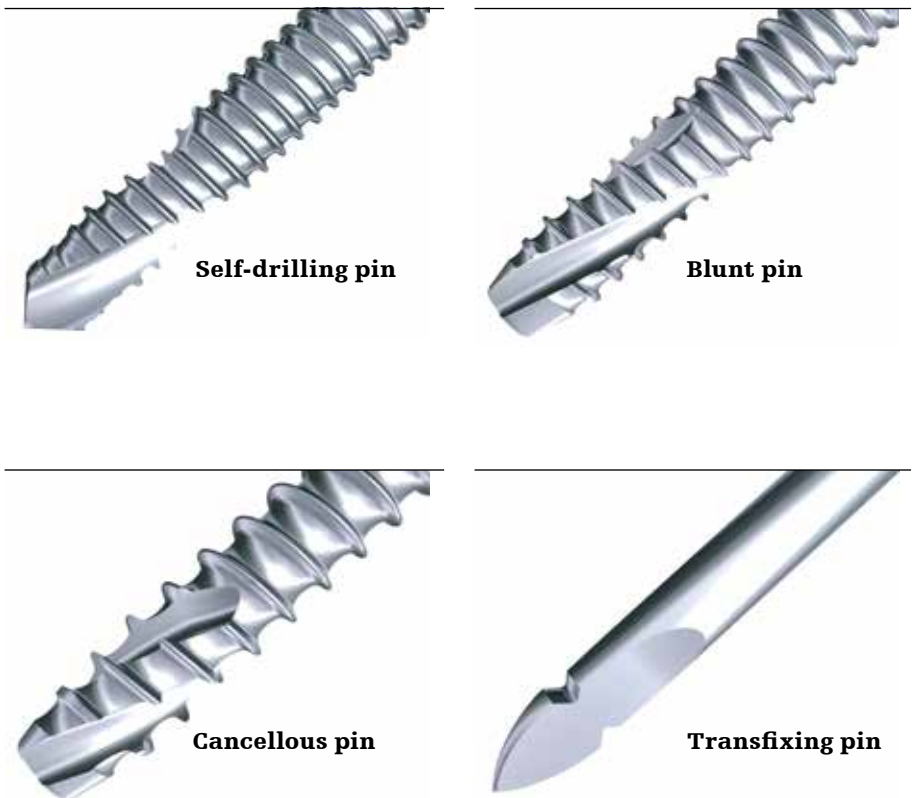

Pin thread diameter	Drill bit	Location
Ø3mm	Ø2.2mm	Ulna, radius, wrist, metacarpal
Ø4mm	Ø3.2mm – Ø3.5mm	Radius, ulna, humerus, tibia, metatarsal
Ø5mm	Ø4.0mm – Ø4.5mm	Tibia, femur, calcaneus, pelvis
Ø6mm	Ø4.5mm – Ø5.0mm	Adult tibia, femur, pelvis

Components

Hybrid Apex pins

Designed with $\varnothing 3\text{mm}$ or $\varnothing 4\text{mm}$ threads while maintaining a $\varnothing 5\text{mm}$ shaft. Hybrid Apex pins are compatible with rod-to-rod delta couplings ($\varnothing 5\text{mm}$ side) and can be used for small bone fixation without opening a small external fixation set.

Hybrid pins are compatible with the universal pin chuck which may increase intra-operative efficiency.

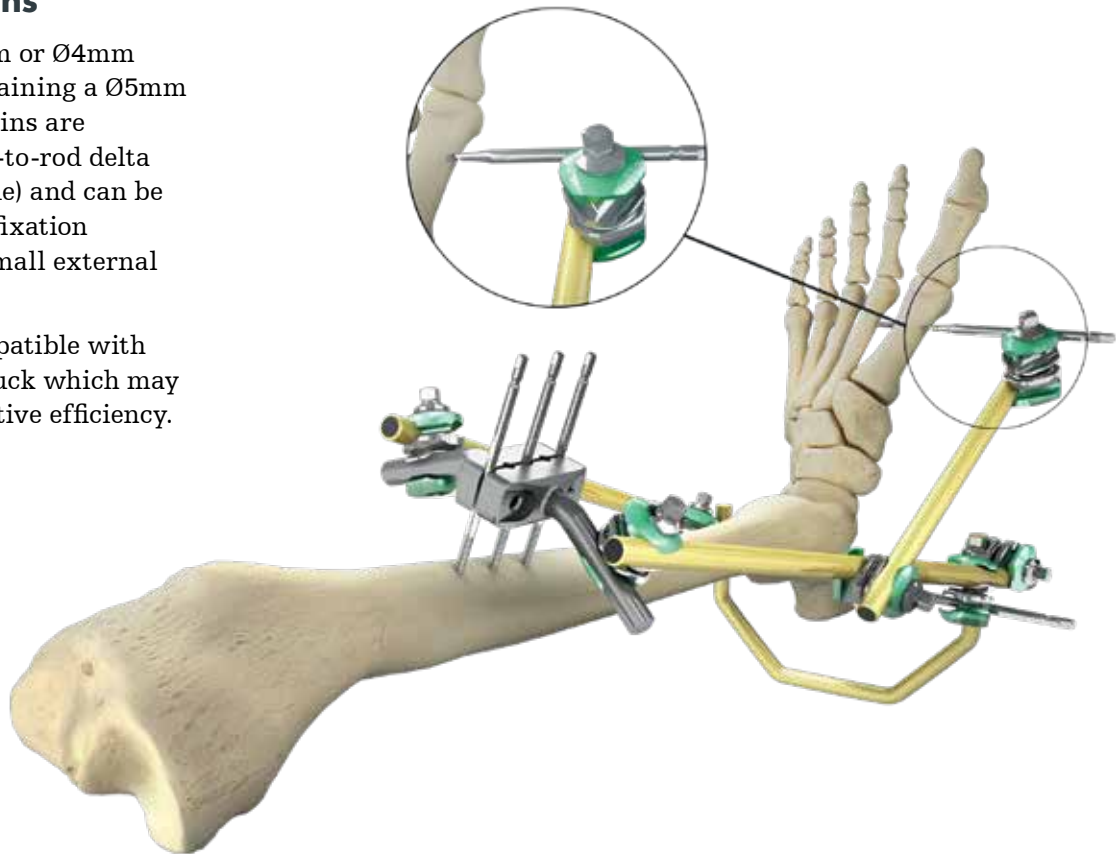

Universal pin chuck

The Universal Pin Chuck with AO coupling accommodates $\varnothing 4$, $\varnothing 5$, and $\varnothing 6\text{mm}$ diameter Apex pins. Use of this instrument may remove the need for multiple chucks for different half pin diameters.



Tibial frames

Pin technique / safe zones

Knowledge of the cross-sectional anatomy of the tibia helps to ensure safe pin placement.

- Apex half pins can be placed in the medial face of the tibia from plateau to pilon
- Transfixing pins can be safely placed except in the distal third of the tibia proximal to the metaphysis and distal to the fibula head near the peroneal nerve
- Before insertion of anterior Apex half pins near the ankle joint, perform blunt dissection to bone to ensure safety of neurovascular bundle

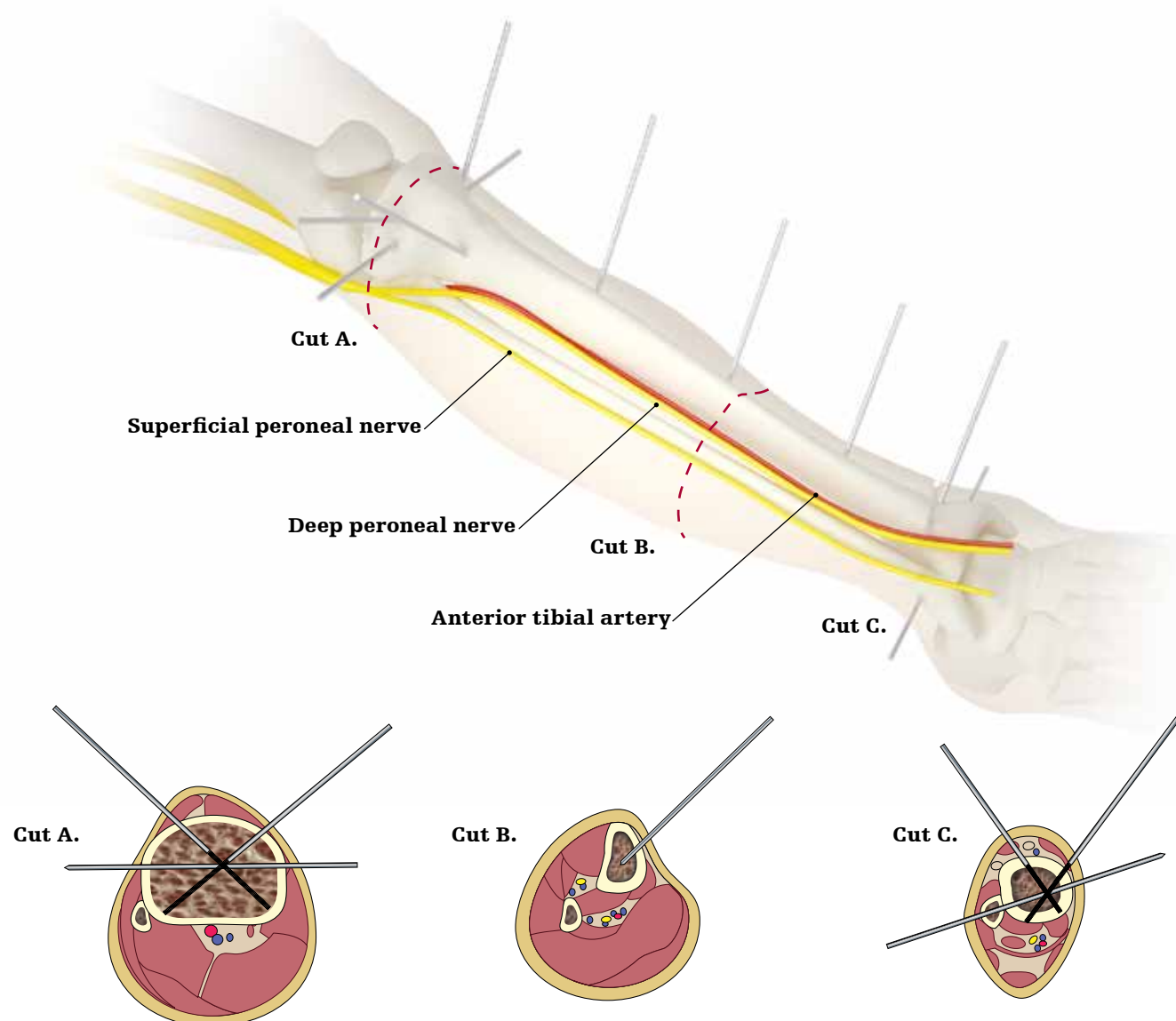

Tibial frames

Tibial standard bi-lateral frame

Parallel pin placement

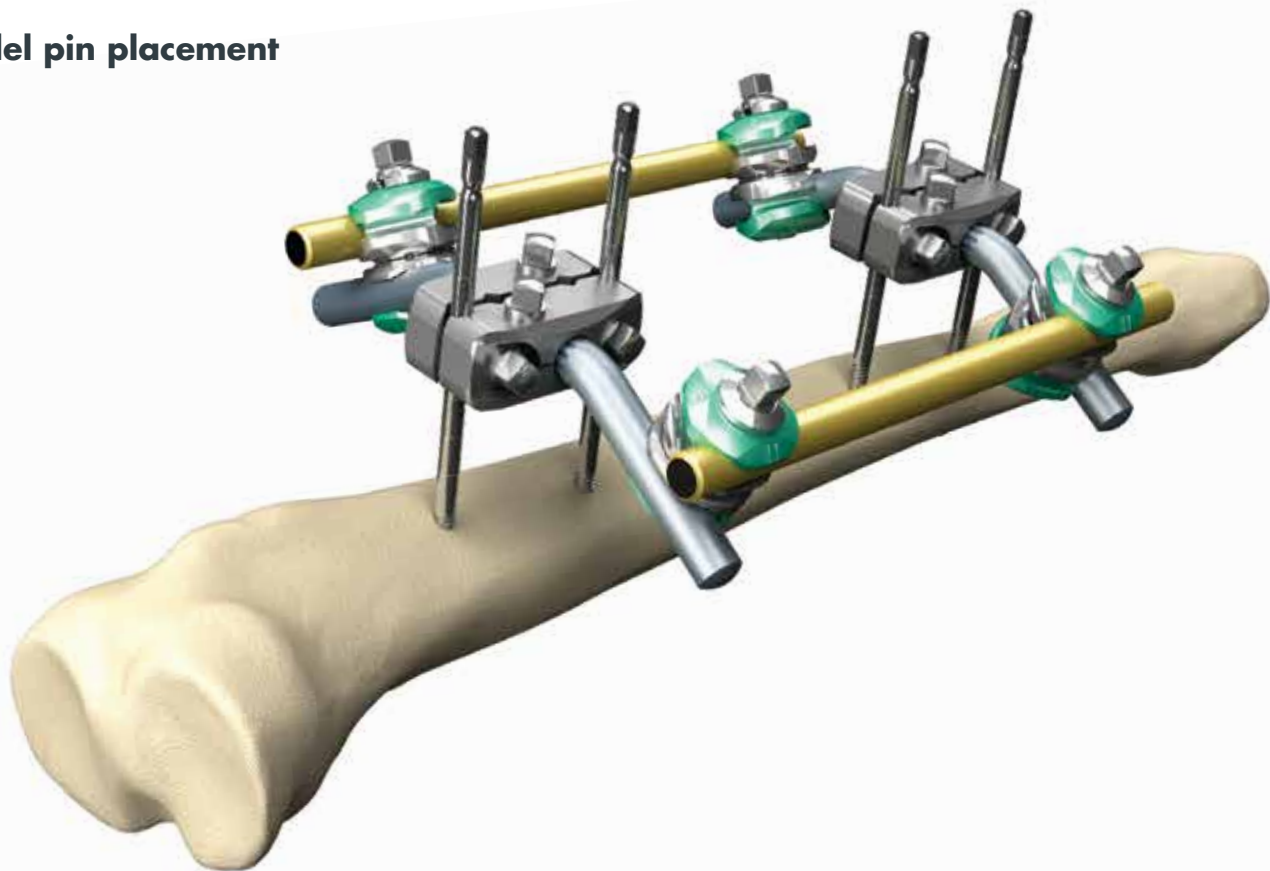

Components list

Ref	Description	Quantity
4922-2-020	5-Hole pin clamp	2
4922-2-140	30° Angled post Ø11mm	4
4922-1-010	Rod-to-rod delta coupling	4
5018-5-150	Apex pin Ø5mm x 150mm	4
4922-8-300	Connecting rod Ø11mm x 300mm	2

NOTICE

Alternatively the pin-to-rod delta couplings can be replaced by multiplanar pin-to-rod delta couplings, thus offering more flexibility and freedom when placing Apex pins and when reducing the fracture before final tightening.

Tibial frames

Tibial single rod frame

Independent pin placement,
with multiplanar delta couplings

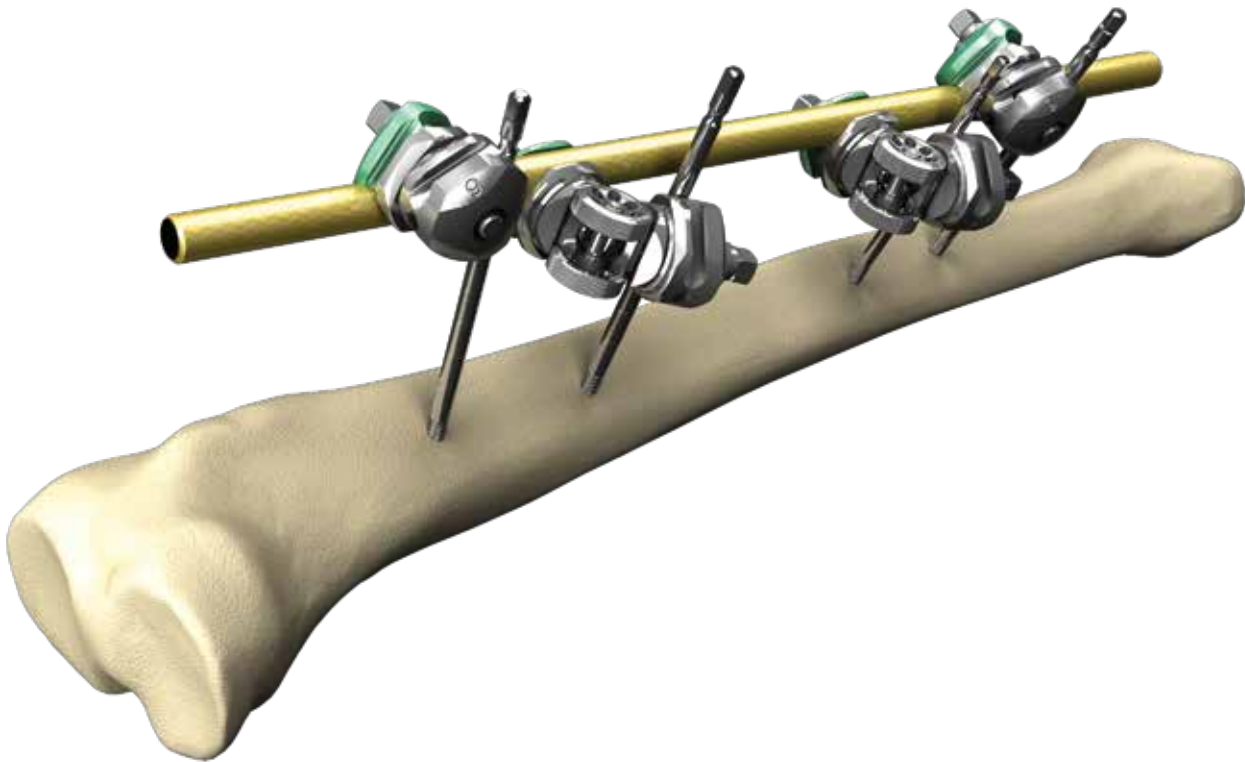

Components list

Ref	Description	Quantity
4922-1-025	Pin-to-rod delta coupling, multiplanar	2
4922-1-020	Pin-to-rod delta coupling	2
5018-5-150	Apex pin Ø5mm x 150mm	4
4922-8-300	Connecting rod Ø11mm x 300mm	1

Tibial frames

Tibial standard osteotaxis half frame

Parallel pin placement

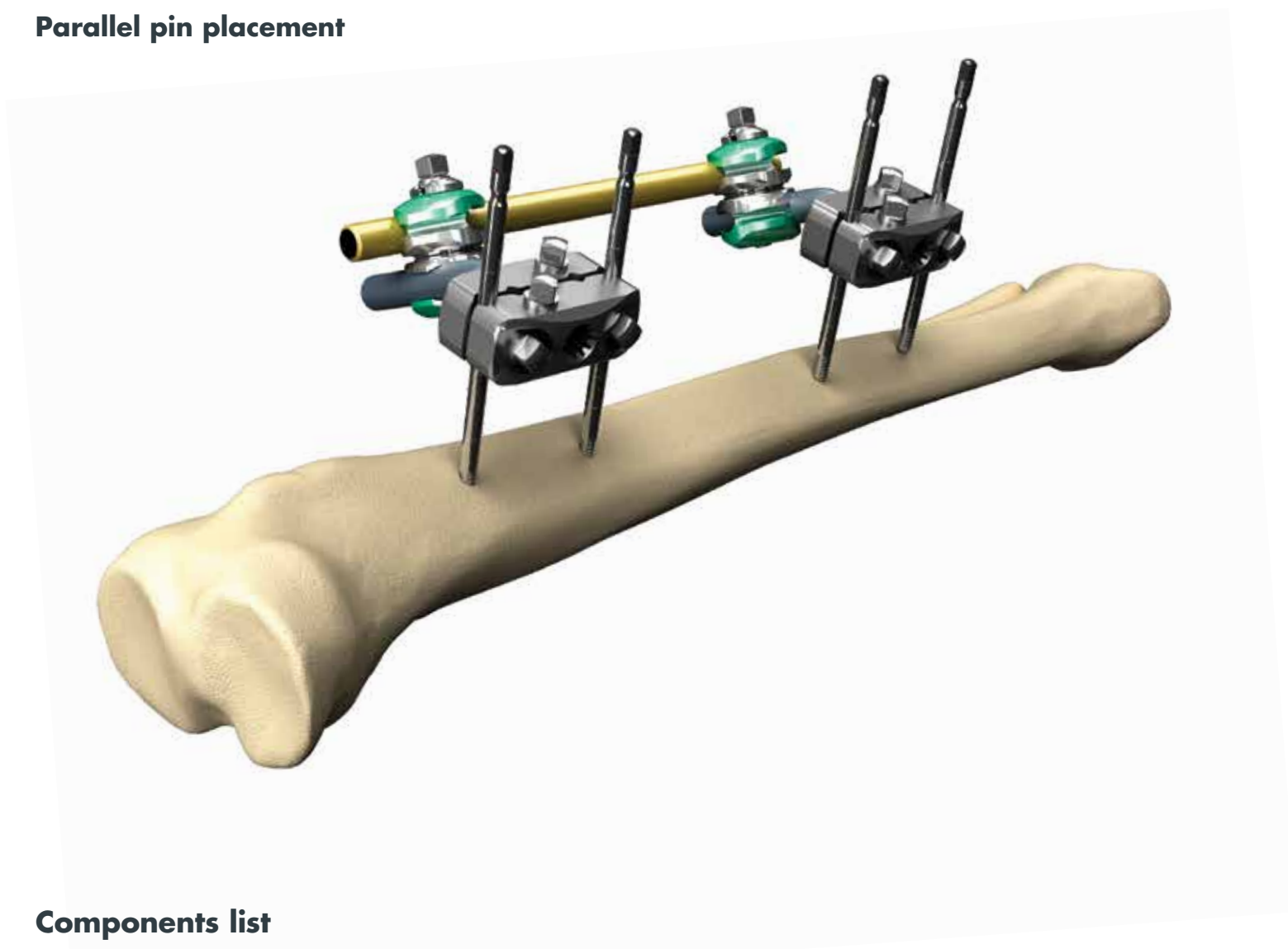

Components list

Ref	Description	Quantity
4922-2-020	5-Hole pin clamp	2
4922-2-140	30° Angled post Ø11mm	2
4922-1-010	Rod-to-rod delta coupling	2
5018-5-150	Apex pin Ø5mm x 150mm	4
4922-8-300	Connecting rod Ø11mm x 300mm	1

Tibial frames

Tibial plateau semi-circular frame

Parallel / independent pin placement

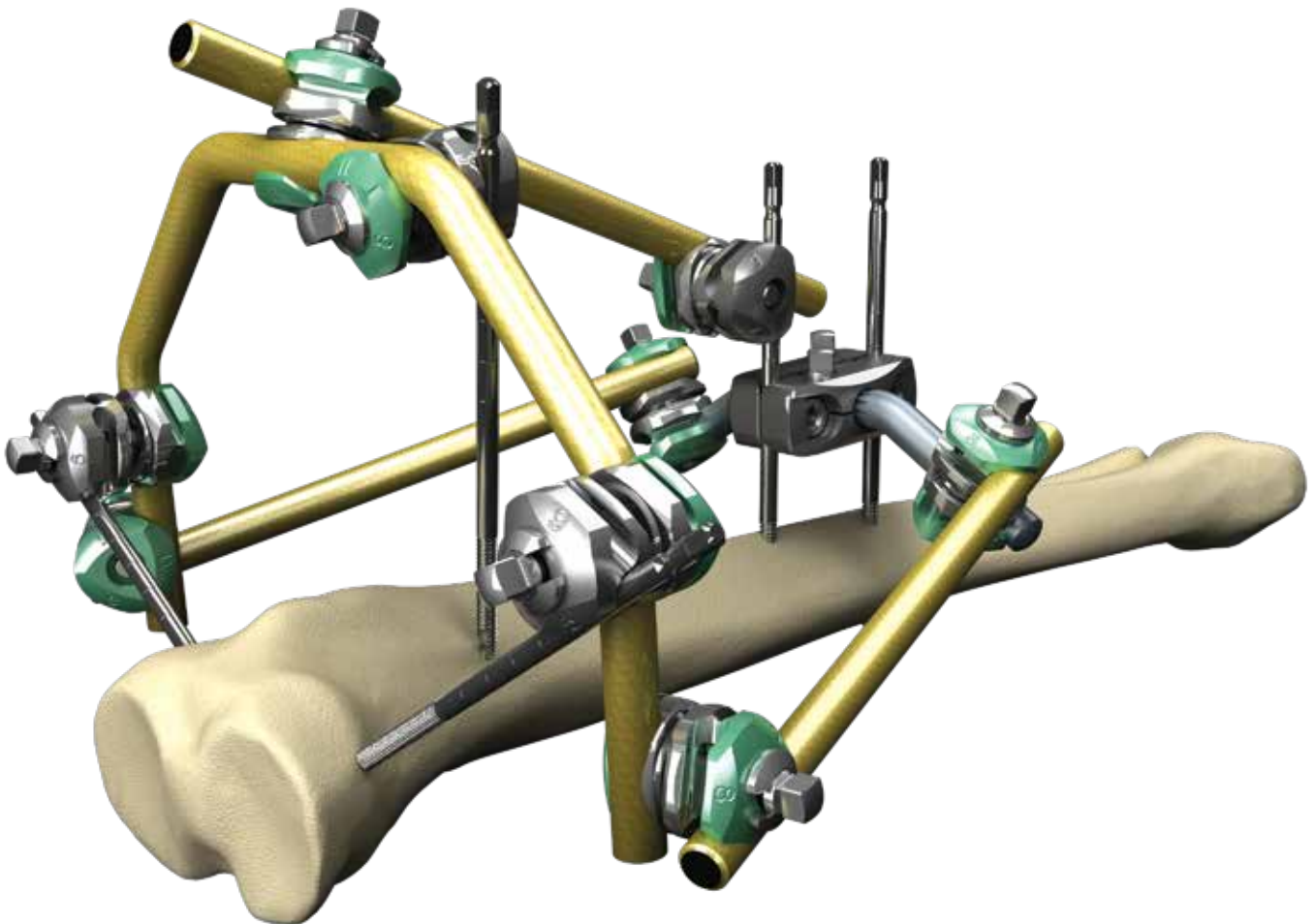

Components list

Ref	Description	Quantity
4922-2-020	5-Hole pin clamp	1
4922-2-140	30° Angled post Ø11mm	2
4922-1-010	Rod-to-rod delta coupling	5
4922-1-020	Pin-to-rod delta coupling	2
4922-1-030	Pin-to-rod delta coupling, inverted	2
5018-5-150	Apex pin Ø5mm x 150mm	5
4922-7-220	Semi circular rod Ø11mm x 220mm	1
4922-8-300	Connecting rod Ø11mm x 300mm	3

Tibial frames

Distal tibia shaft frame

Parallel / independent pin placement

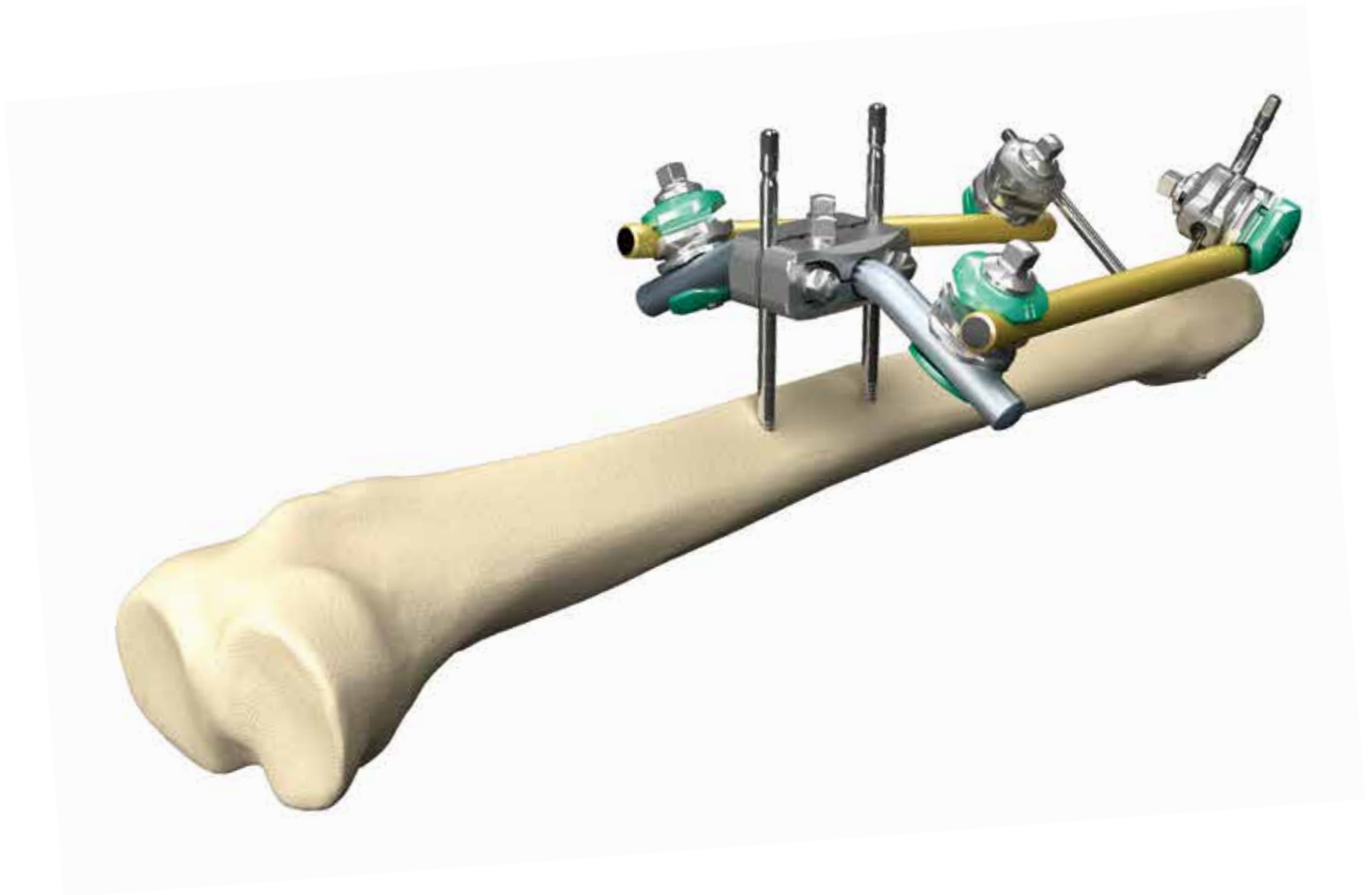

Components list

Ref	Description	Quantity
4922-2-020	5-Hole pin clamp	1
4922-2-140	30° Angled post Ø11mm	2
4922-1-010	Rod-to-rod delta coupling	2
4922-1-020	Pin-to-rod delta coupling	2
5018-5-150	Apex pin Ø5mm x 150mm	4
4922-8-250	Connecting rod Ø11mm x 250mm	2

Ankle frames

Pin technique / safe zones

Knowledge of the cross-sectional anatomy of the ankle helps to ensure safe pin placement.

- Apex half pins can be placed proximal to the ankle from medial to lateral in the anteromedial face of the tibia
- Apex pins can be placed distal to the crossing of the anterior tibial vessels just proximal to the ankle
- Before insertion of anterior Apex half pins near ankle joint, perform blunt dissection to bone to ensure safety of neurovascular bundle
- Hybrid pins can be placed from the medial or dorsomedial side 0-115° from the frontal plane
- Transfixing pins can be placed through the calcaneus from medial to lateral

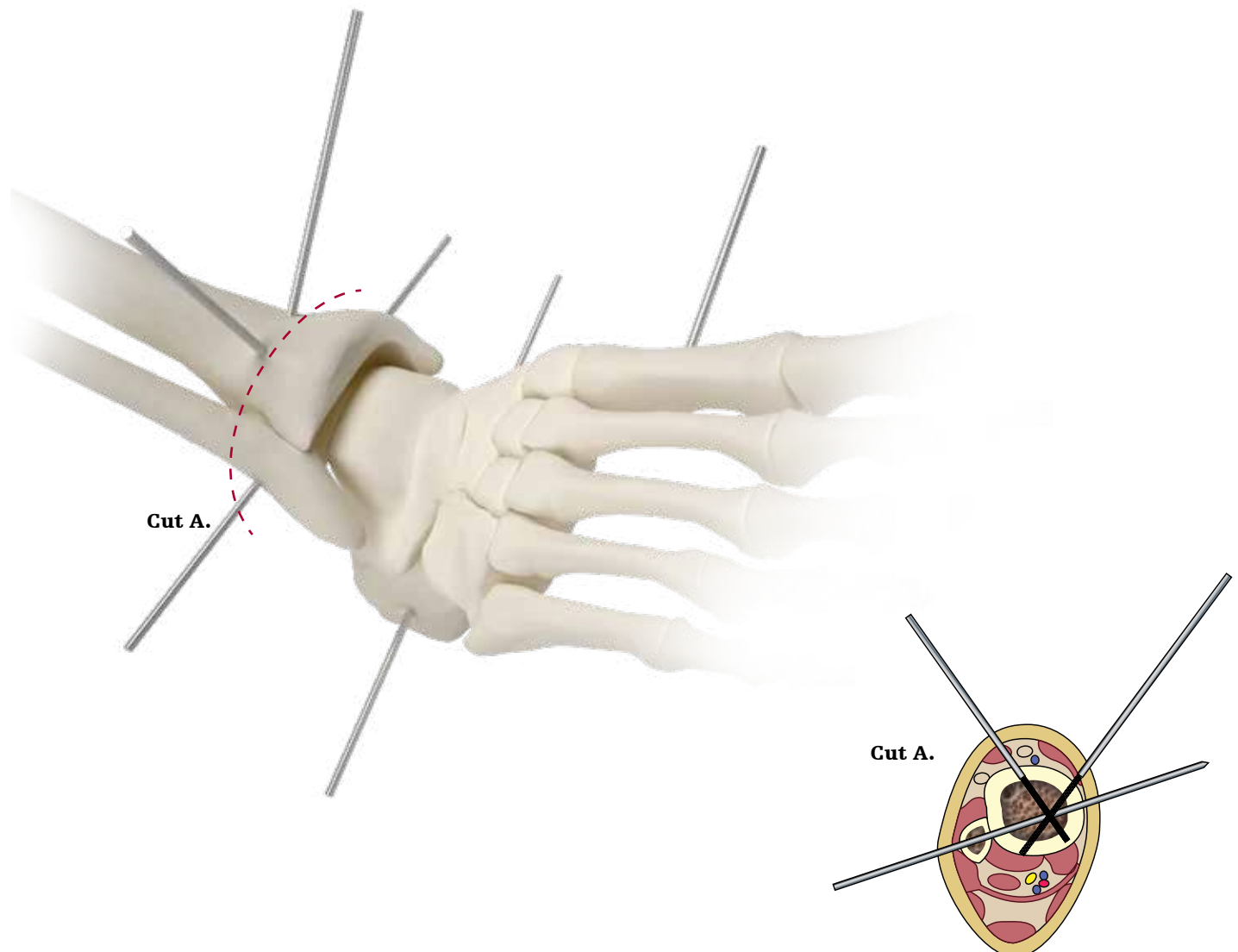

Ankle frames

Ankle delta frame

Parallel pin placement / semi-circular rod used as a kick-stand / foot stabilizing Ø3 / 5mm hybrid Apex pin

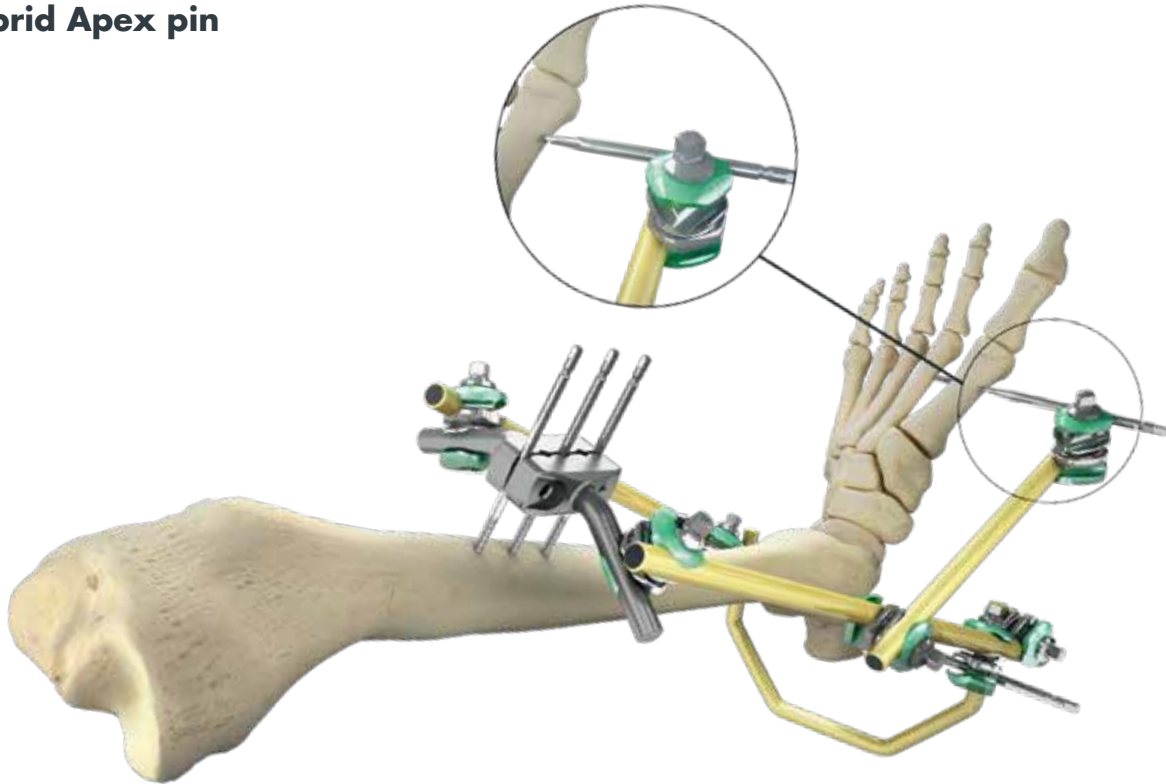

Components list

Ref	Description	Quantity
5050-4-300	Transfixing pin Ø5mm / Ø6mm, Ø300mm x Ø40mm	1
5018-5-150	Apex pin Ø5 x Ø150mm	3
5026-8-120	Self-drilling hybrid half pin Apex Ø3 / Ø5mm, Ø120 x Ø20mm	1
4922-1-010	Rod-to-rod delta coupling	8
4922-2-020	5-Hole pin clamp	1
4922-2-140	30° Angled posts Ø11mm	2
4922-7-220	Semi circular rod Ø11 x Ø220mm	1
4922-8-350	Connecting rod Ø11 x Ø350mm	2
4922-8-200	Connecting rod Ø11 x Ø200mm	1

NOTICE

Alternatively the 5-hole pin clamp with posts can be replaced by a pre-welded 5-hole pin clamp with fixed posts (Ref 4922-2-240).

Ankle frames

Ankle bridging frame

Parallel pin placement



Components list

Ref	Description	Quantity
5018-5-150	Apex pin Ø5mm x Ø150mm	2
5030-5-200	Transfixing pin Ø5mm / Ø4mm x Ø200mm	2
4922-1-010	Rod-to-rod coupling	4
4922-2-020	5-Hole pin clamp	3
4922-2-120	Straight post Ø11mm	2
4922-2-140	30° Angled post Ø11mm	2
4922-8-250	Connecting rod Ø11mm x Ø250mm	2

NOTICE

- Alternatively the 5-hole pin clamp with straight posts can be replaced by a pre-welded 5-hole pin clamp with fixed posts (Ref 4922-2-220).
- Alternatively to the Ø4mm transfixing pin with Ø5mm thread we recommend the Ø5mm transfixing pin 300mm x 40mm with Ø6mm thread (Ref 5050-4-300).

Femur frames

Pin technique / safe zones

Knowledge of the cross-sectional anatomy of the femur helps to ensure safe pin placement.

- Apex half pins can be placed in the femur from lateral to medial along the entire length of the bone
- Transfixing pins can be placed in the distal quarter of the femur distal to the passage of the femoral artery posteriorly

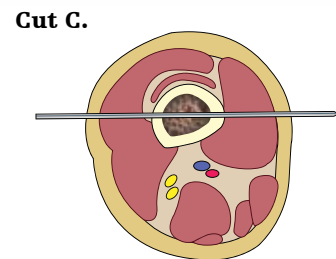
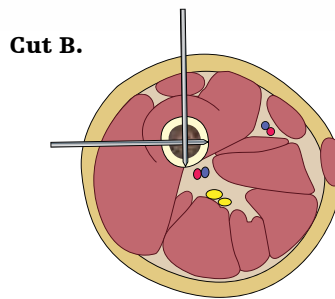
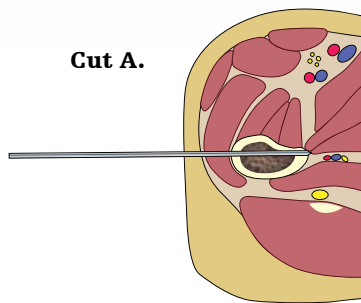
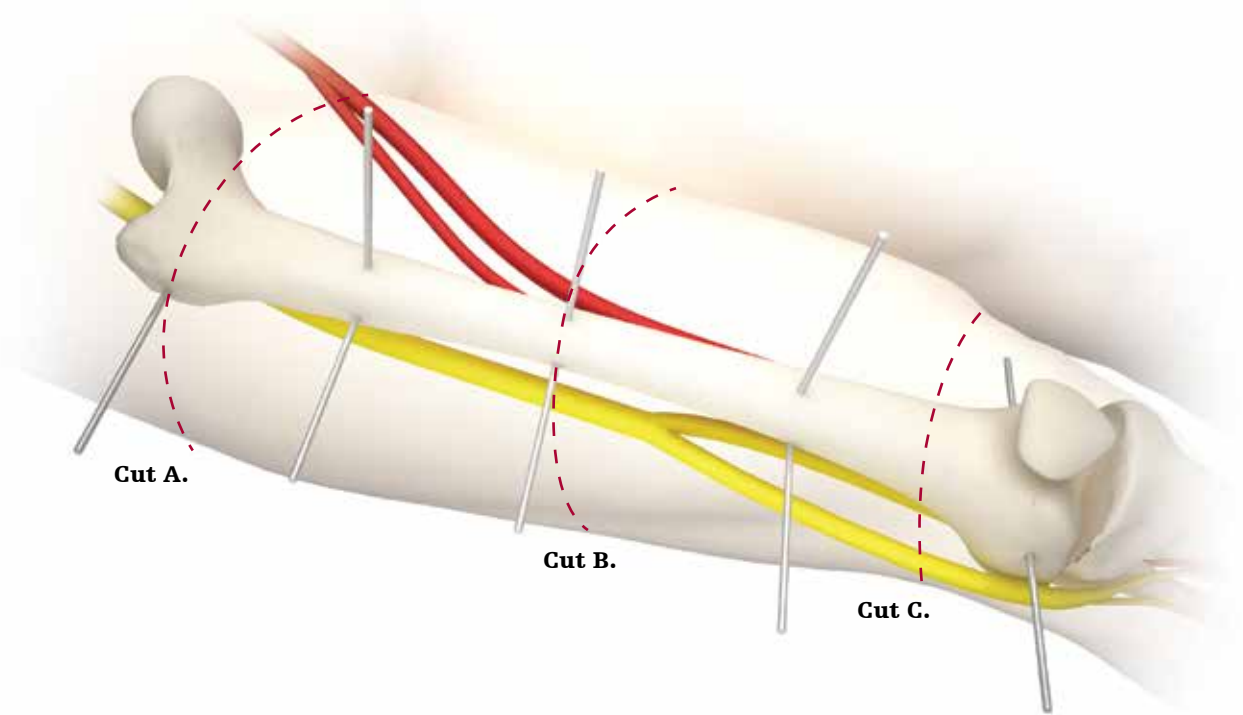

Femur frames

Femur emergency frame

Independent pin placement

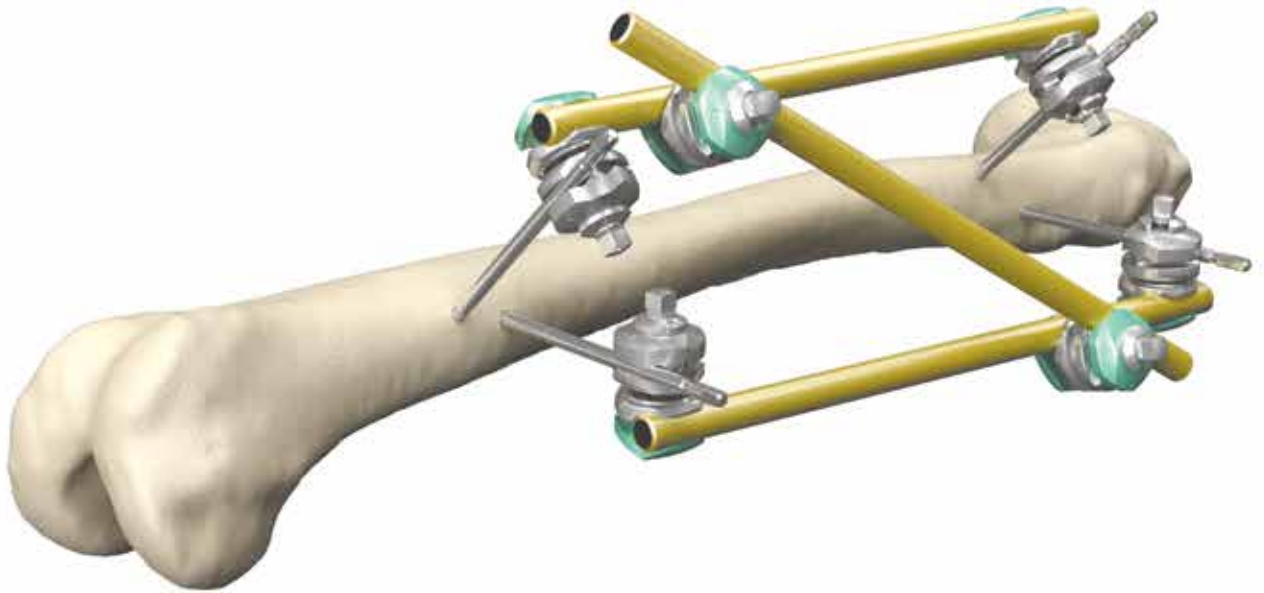

Components list

Ref	Description	Quantity
4922-1-020	Pin-to-rod delta coupling	4
4922-1-010	Rod-to-rod delta coupling	2
5021-6-180	Apex pin Ø6mm x 180mm	4
4922-8-350	Connecting rod Ø11mm x 350mm	3

NOTICE

Apply additional pins and rods before patient transportation.

Knee frames

Pin technique / safe zones

- Apex half pins can be placed anterolaterally in the femur, and anteromedially in the tibia.

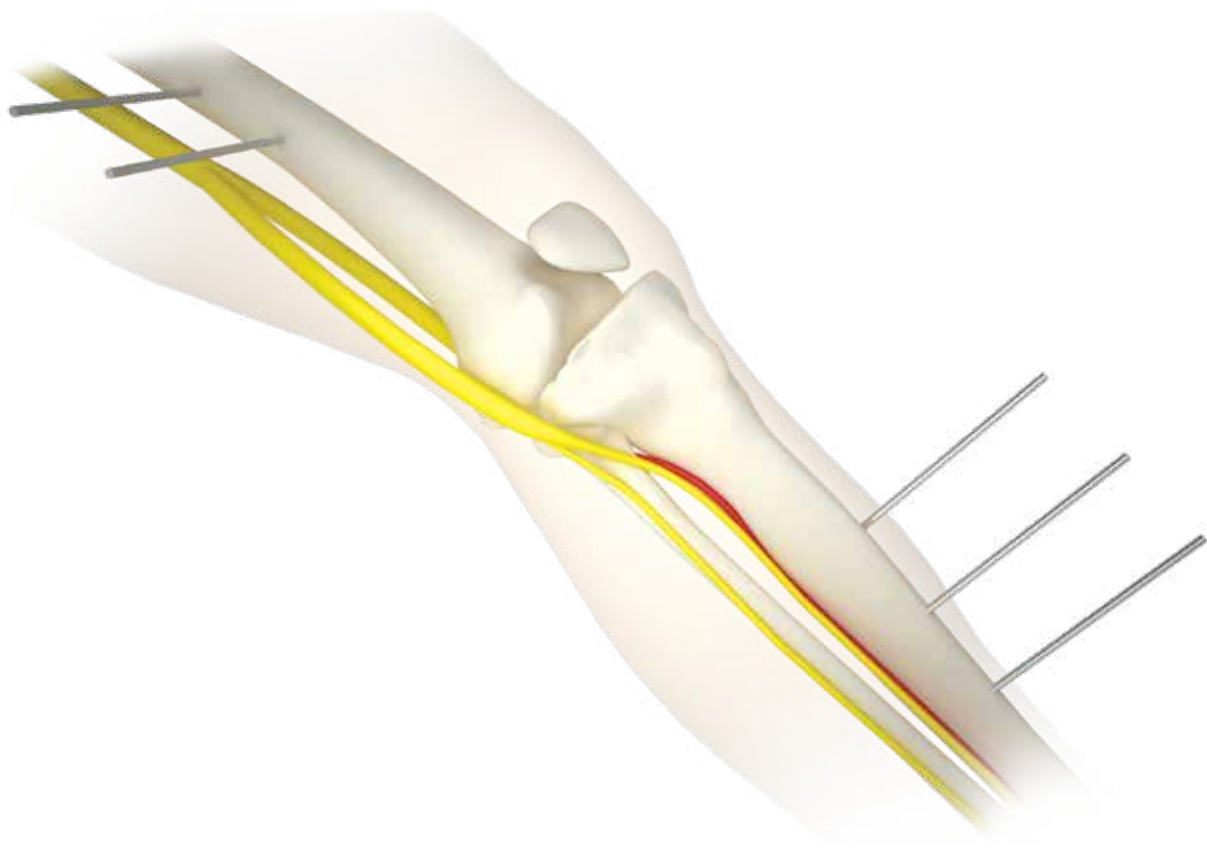

Knee frames

Knee bridging frame

Independent pin placement, with rod coupler

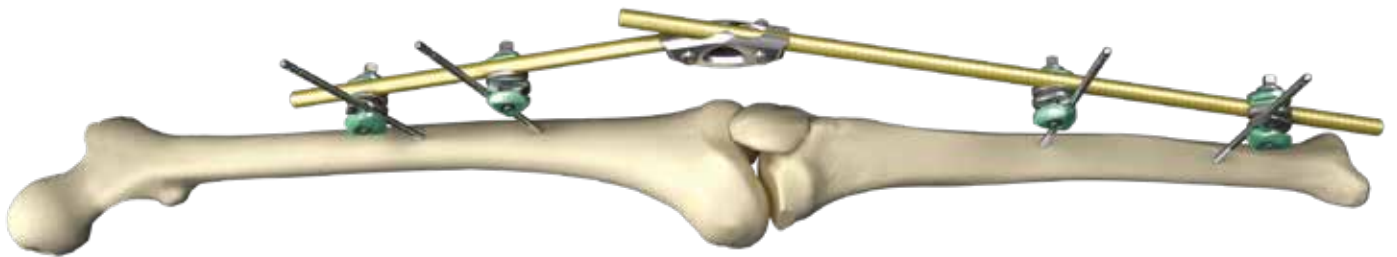

Components list

Ref	Description	Quantity
4922-1-020	Pin-to-rod delta coupling	4
5018-6-180	Apex pin Ø5mm x 180mm	4
4922-1-220	Rod coupler, 30°	1
4922-8-450	Connecting rod Ø11mm x 450mm	1
4922-8-350	Connecting rod Ø11mm x 350mm	1

NOTICE

Alternatively pin-to-rod delta couplings can be replaced by multiplanar pin-to-rod delta couplings, thus offering more flexibility and freedom when placing Apex pins. A rod-to-rod delta coupling could also be used in place of a rod coupler

Knee frames

Knee bridging frame

Independent pin placement

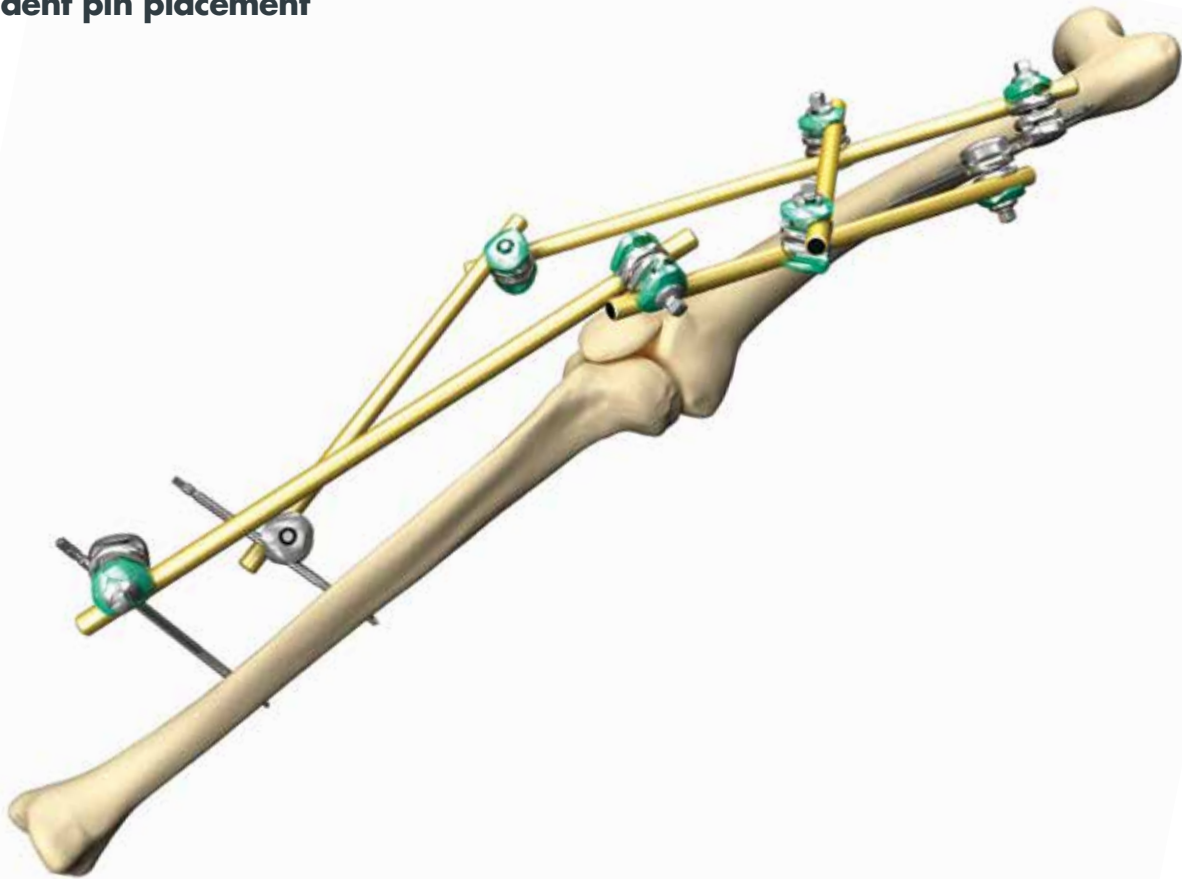

Components list

Ref	Description	Quantity
4922-1-020	Pin-to-rod delta coupling	4
4922-1-010	Rod-to-rod delta coupling	4
5021-6-180	Apex pin Ø6mm x 180mm	2
5018-6-180	Apex pin Ø5mm x 180mm	2
4922-8-350	Connecting rod Ø11mm x 350mm	4
4922-8-200	Connecting rod Ø11mm x 200mm	1

Knee frames

Knee bridging z-frame

Independent pin placement, with rod coupler

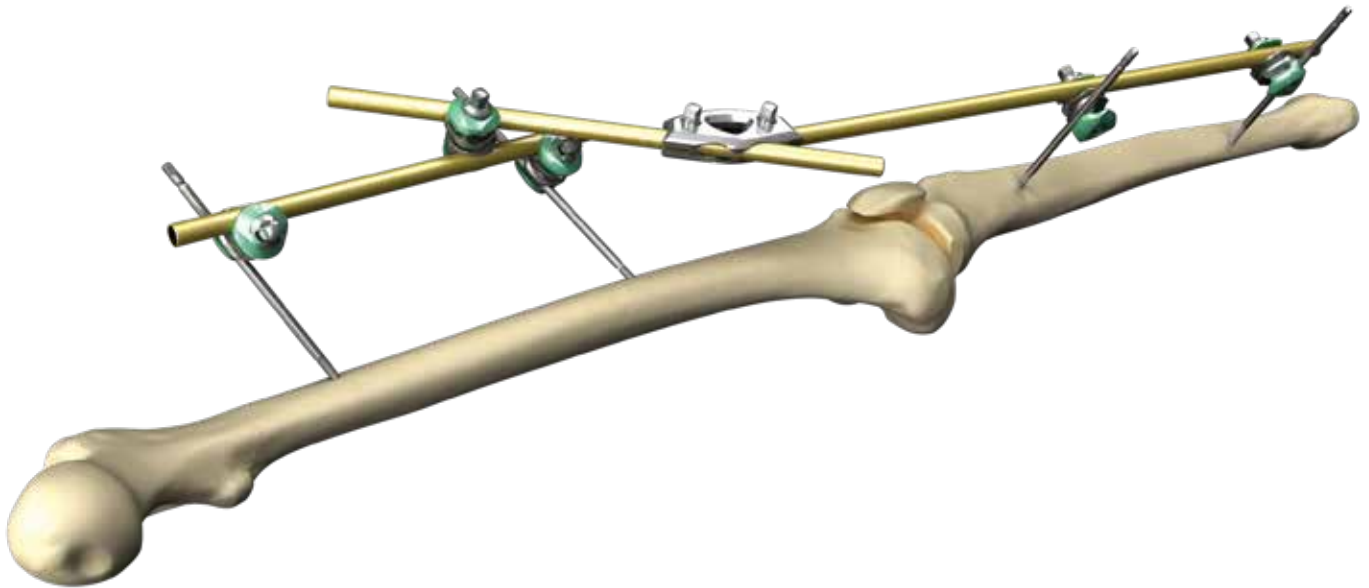

Components list

Ref	Description	Quantity
4922-1-020	Pin-to-rod delta coupling	4
4922-1-010	Rod-to-rod delta coupling	1
5018-6-180	Apex pin Ø5mm x 180mm	4
4922-1-220	Rod coupler, 30°	1
4922-8-400	Connecting rod Ø11mm x 400mm	2
4922-8-250	Connecting rod Ø11mm x 250mm	1

NOTICE

Alternatively pin-to-rod delta couplings can be replaced by multiplanar pin-to-rod delta couplings, thus offering more flexibility and freedom when placing Apex pins. A rod-to-rod delta coupling could also be used in place of a rod coupler.

Pelvic frames

Pin technique / safe zones

Knowledge of the cross-sectional anatomy of the pelvis helps to ensure safe pin placement.

- Apex half pins can be placed in the iliac wings
- Apex half pins can be placed in the pelvis in the crest between the anterior-superior and anterior inferior iliac spines

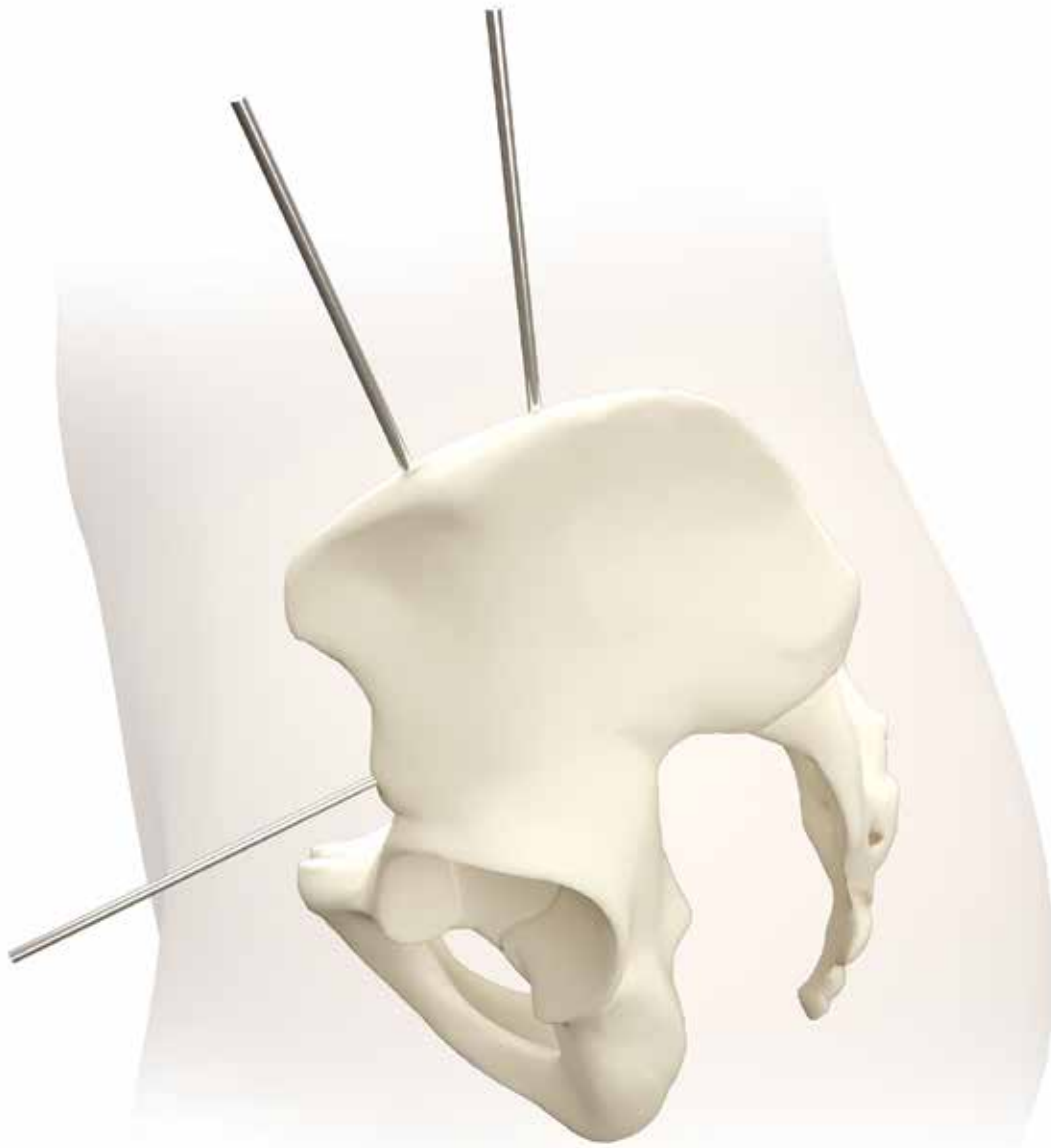

Pelvic frames

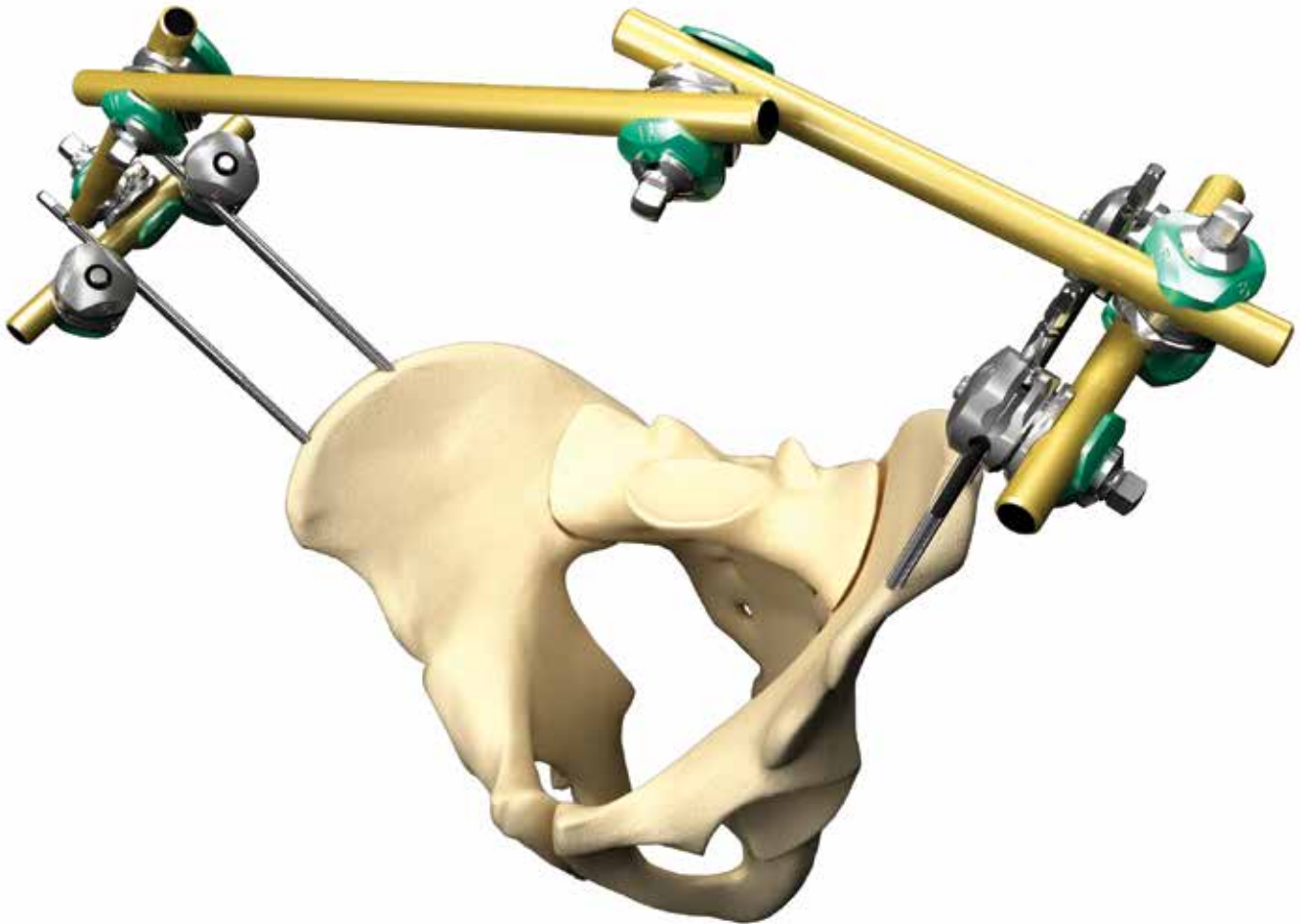
Pelvic osteotaxis frame**Independent iliac crest pin placement****Components list**

Ref	Description	Quantity
4922-1-030	Pin-to-rod delta coupling, inverted	4
4922-1-010	Rod-to-rod delta coupling	4
5018-6-200	Apex pin Ø5mm x 200mm	4
4922-8-350	Connecting rod Ø11mm x 350mm	3
4922-8-150	Connecting rod Ø11mm x 150mm	2

Pelvic frames

Pelvic osteotaxis frame

**Independent iliac crest pin placement,
with rod coupler**

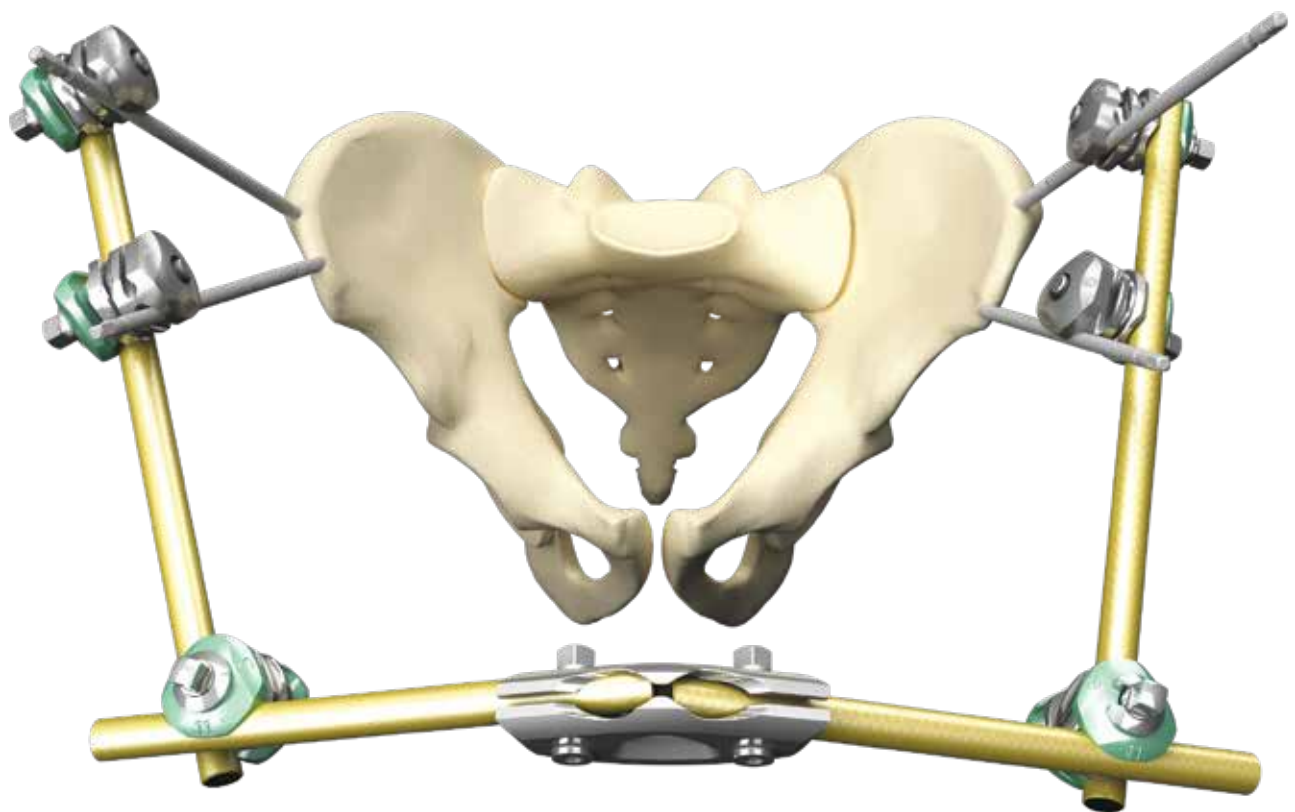

Components list

Ref	Description	Quantity
4922-1-030	Pin-to-rod delta coupling, inverted	4
4922-1-010	Rod-to-rod delta coupling	2
4922-1-220	Rod coupler, 30°	1
4922-8-150	Connecting rod Ø11mm x 150mm	2
4922-8-250	Connecting rod Ø11mm x 250mm	2
5018-6-180	Apex pin Ø5 x 180mm	4

Pelvic frames

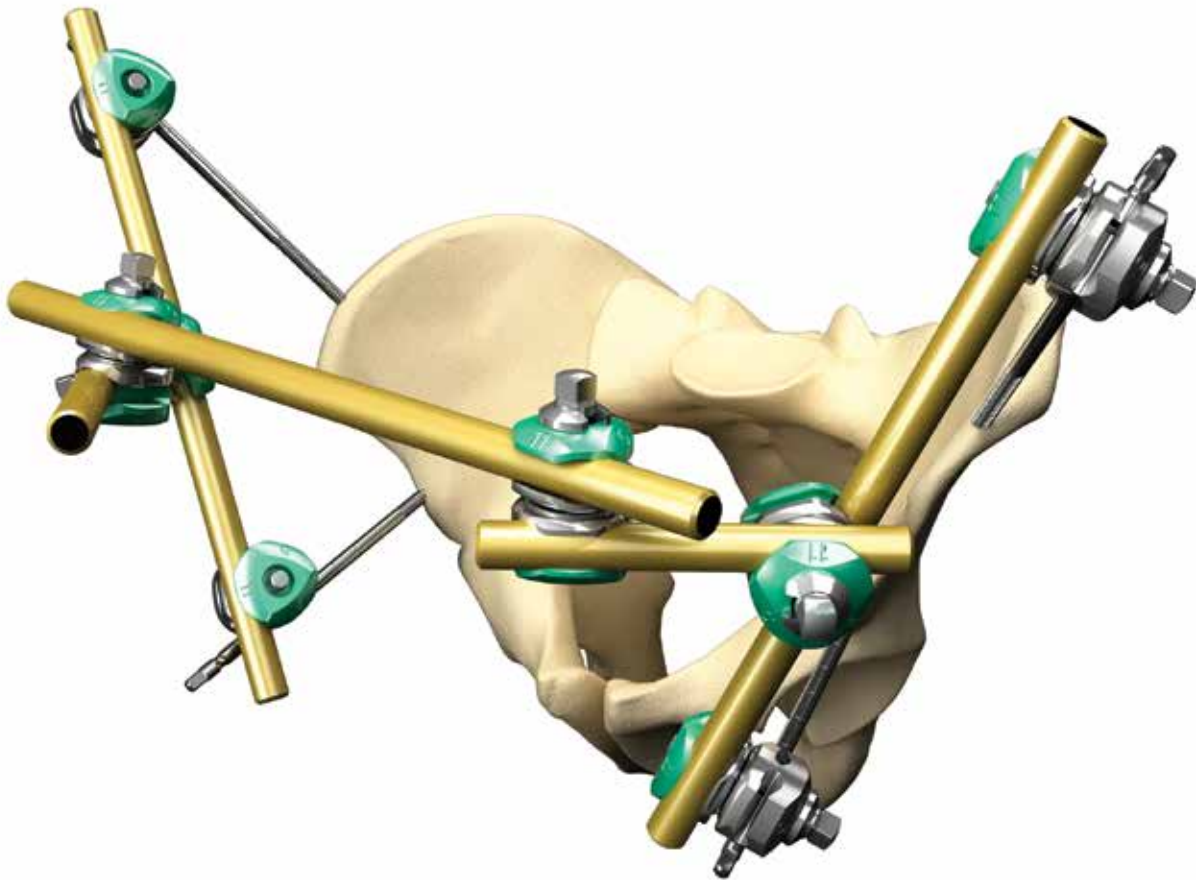
Pelvic orthogonal frame construct**Perpendicular iliac crest / supra-acetabular pin placement****Components list**

Ref	Description	Quantity
4922-1-020	Pin-to-rod coupling	4
4922-1-010	Rod-to-rod coupling	3
5018-6-200	Apex pin Ø5mm x 200mm	4
4922-8-350	Connecting rod Ø11mm x 350mm	2
4922-8-150	Connecting rod Ø11mm x 150mm	2
4922-8-400	Connecting rod Ø11mm x 400mm	1

Military or disaster recovery kits

Vision, global engineering, Swiss manufacturing

The Hoffmann 3 Sterile Field Kits A and B contain scalpels, mosquito clamps, self-drilling Apex pins, a manual drill-brace for pin insertion and frame tightening, Hoffmann 3 Delta Couplings (Kit A also includes 5-hole pin clamps) and Ø11mm vectran coated carbon fiber connecting rods for the temporary stabilization of diverse fracture patterns.

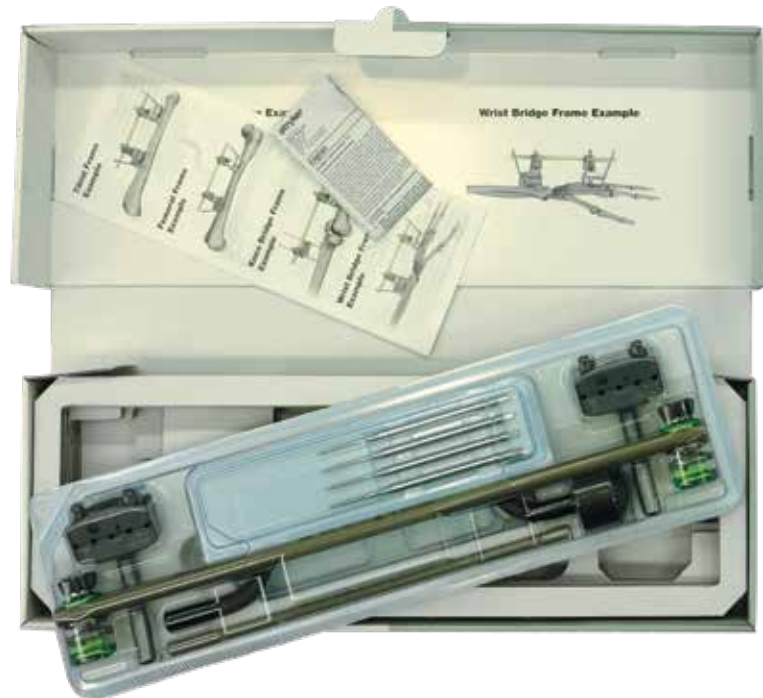

Sterile Field Kit A
Ref: 4922-9-940S



Sterile Field Kit B
Ref: 4922-9-941S

Sterile field kit A

Femoral safe zone

Between anterolateral and lateral sites

Antero-lateral

Distal from the greater trochanter to 3-4 fingers proximal to patella

Lateral

Distal from the greater trochanter to 1-2 fingers proximal to knee joint



Tibial Safe Zone

Medial

1-2 fingers distal to knee joint avoiding patella tendon and tibial tubercle

1 finger proximal to ankle



Sterile field kit A

Hoffmann 3 Sterile Field Kit A application technique:

Step 1:

Provisionally reduce and align the limb. Apply self drilling, self tapping Apex pins through 1cm linear incision of the soft tissue made down to the bone with the scalpel. The included hemostat clamp may be used to spread soft tissues before pin insertion.

Step 2:

Pins are placed through both cortices using the black brace, "pin end," as shown.

Step 3:

Insert the first pin 2-3 finger breadth proximal to the fracture / bone defect (Fig. 1)*.

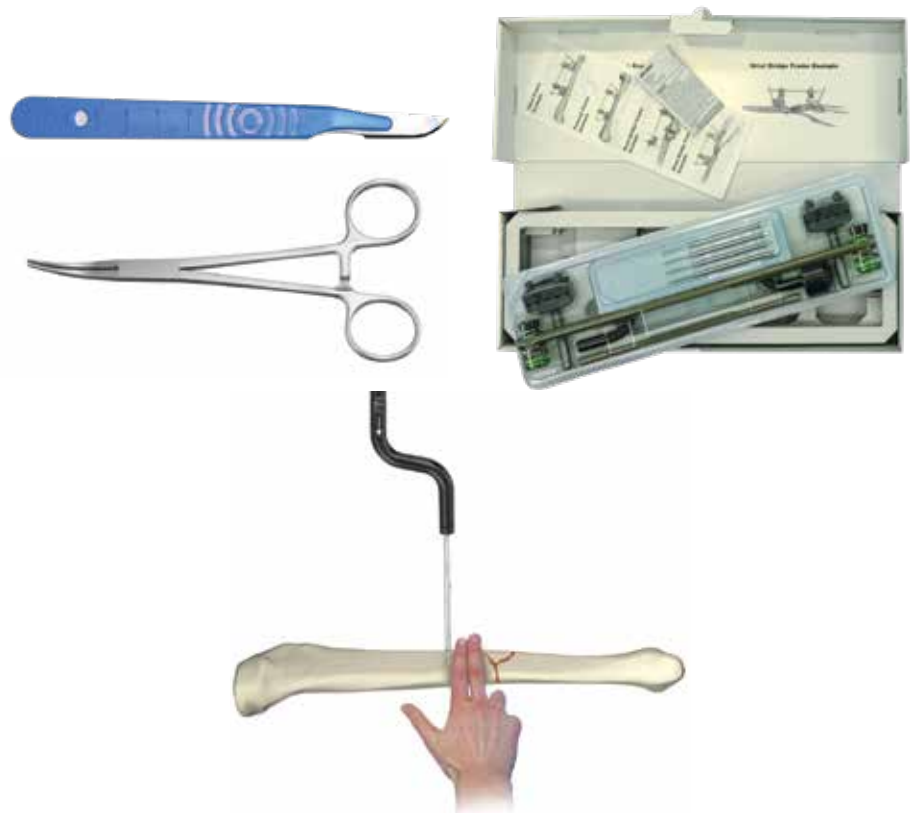

Fig. 1

NOTICE

In emergency situations often there is no X-ray (fluoroscopy) available. Under such circumstances it is not possible to localize the fracture site accurately. Therefore, it is recommended to place the Apex pins in an area which is in a safe distance proximally and distally from the fracture site.

Step 4

The insertion point of the Apex pin in the first cortex should be positioned exactly in the center of the cross-section of the bone to avoid excentric or tangential positioning (Fig. 2). After penetration of the first cortex, a drop in resistance will be detected. Using light pressure, insertion of the pin is continued.

Once firm resistance of the second cortex is felt, six complete revolutions of the drill brace will put the pin tip through the second cortex (Fig. 2).

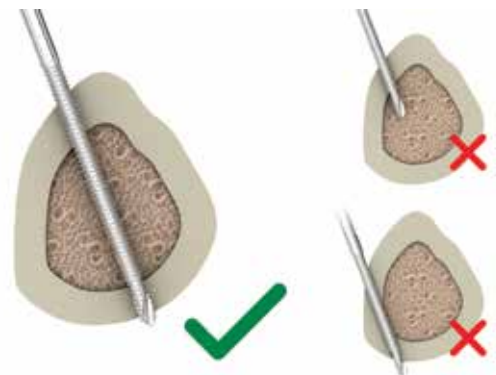

Fig. 2

Sterile field kit A

Step 5:

Place 5-hole pin clamp over first Apex pin, using the widest placement possible. Keep the clamp screws facing up and out (medial), as shown (Fig. 3). As mentioned above: keep safe distance from the fracture site.

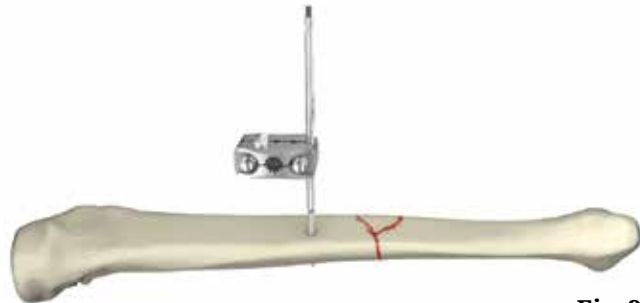

Fig. 3

Step 6:

Insert second proximal pin maintaining parallel alignment with the first pin, using the clamp as a guide (Fig. 4).

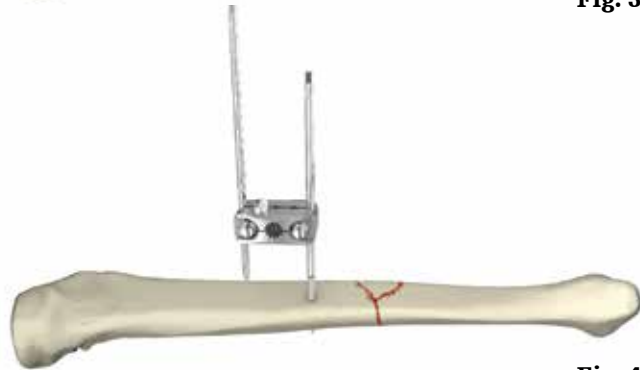

Fig. 4

Step 7:

Repeat the process for the two distal pins, keeping the pins parallel and at least two finger breadth away from the fracture/ bone defect (Fig. 5).

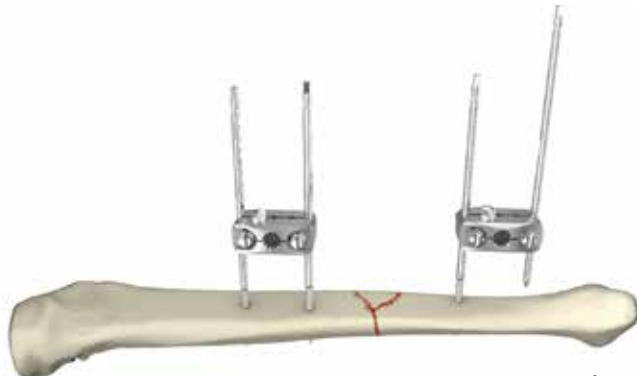

Fig. 5

Step 8:

In the next step attach the rod-to-rod delta couplings with the connecting rod. With frame in place and fracture reduced, fully tighten all nuts, using the drill brace end marked "clamp".

In case the frame is not used in the pre-assembled manner, use the following instructions to assemble the frame.

Sterile field kit A

Step 9:

Attach the delta rod-to-rod couplings as shown. Use care to avoid the 30° bend area when tightening the couplings onto the posts (Fig. 6).



Fig. 6

Step 10:

Snap a connecting rod to the coupling. Provisionally tighten using the thumbwheel (Fig. 7).

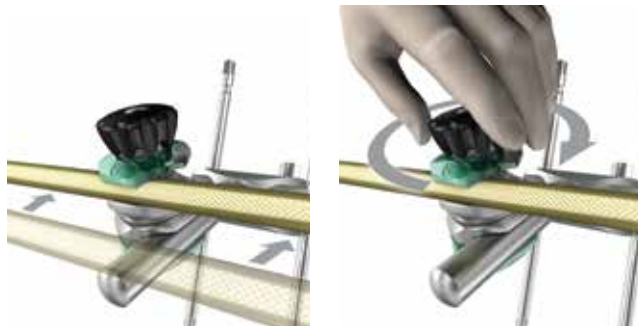

Fig. 7

Step 11:

Remove the thumbwheel from the rod-to-rod coupling to prepare for final tightening (Fig. 8).



Fig. 8

Step 12:

Use the "clamp" end of the brace for final tightening while maintaining reduction and alignment of the limb. Repeat for all clamps and couplings (Fig. 9).



Fig. 9

Sterile field kit A

Tibial frame example

(With Ø11mm connecting rod, Ø5mm Apex pins).



Femoral frame example

(With Ø11mm connecting rod, Ø5mm Apex pins).

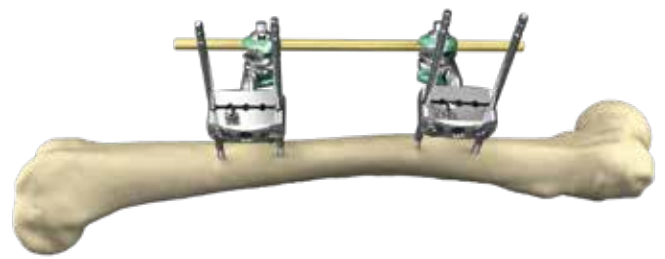

Knee bridge frame example

(With Ø11mm connecting rod, Ø5mm Apex pins).

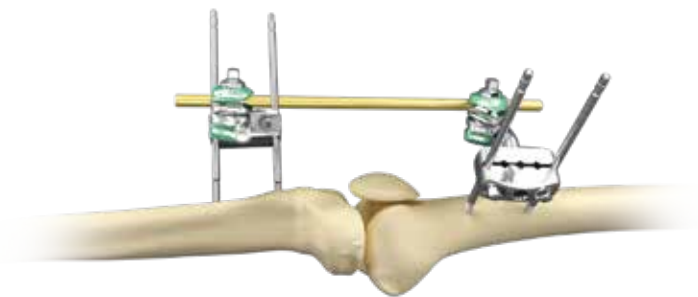

Wrist bridge frame example

(With Ø8mm connecting rod, Ø3 / Ø5mm Apex pins).

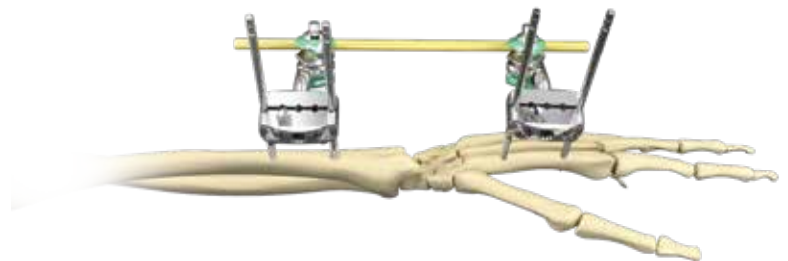

Sterile field kit B

Femoral safe zone

Between anterolateral and lateral sites.

Antero-lateral

Distal from the greater trochanter to 3-4 fingers proximal to patella.

Lateral

Distal from the greater trochanter to 1-2 fingers proximal to knee joint.



Tibial safe zone

Medial

1-2 Fingers distal to knee joint avoiding patella tendon and tibial tubercle 1 finger proximal to ankle.



Pin placement for pelvic emergency frame; pin technique / safe zones

Pins can be placed percutaneously in the iliac wings or in the crest between the anterior-superior and anterior-inferior iliac spines.

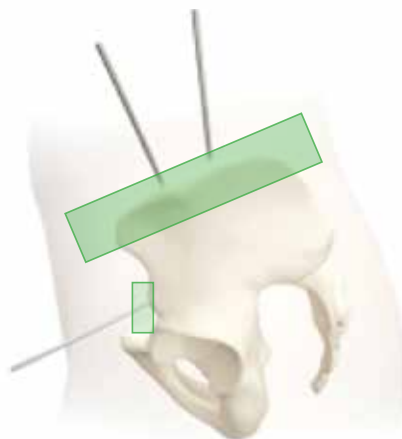

Sterile field kit B

Step 1:

Provisionally reduce and align the limbs. Apply self drilling, self tapping Apex pins by inserting through 1cm linear incision of the soft tissue made down to the bone with the scalpel. The included hemostat clamp may be used to spread soft tissue before pin insertion.



Step 2:

Attach the delta rod-to-rod couplings as shown. Use care to avoid the 30° bend area when tightening the couplings onto the posts (Fig. 6).

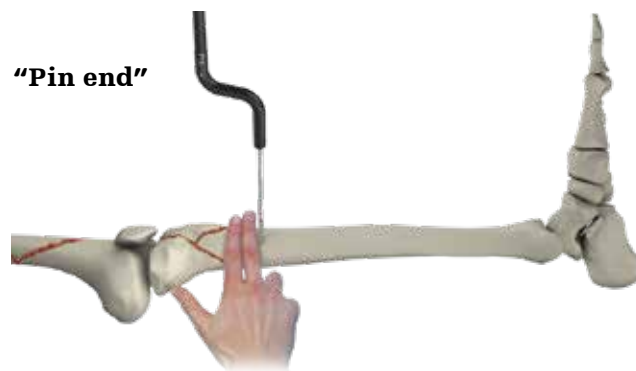

Fig. 1

Step 3:

Insert the first pin 2-3 finger breadth away from the fracture / bone defect (Fig 1)*.

NOTICE

In emergency situations often there is no X-ray (fluoroscopy) available. Under such circumstances it is not possible to localize the fracture site accurately. Therefore, it is recommended to place the apex pins in an area which is in a safe distance from the fracture site.

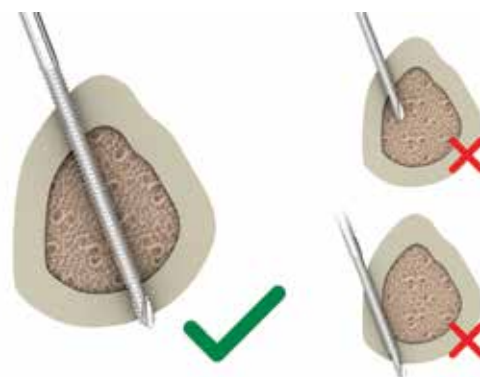

Fig. 2

Sterile field kit B

Step 4:

The insertion point of the Apex pin in the first cortex should be positioned exactly in the center of the cross-section of the bone to avoid excentric or tangential positioning (Fig. 2).

After penetration of the first cortex, a drop in resistance will be detected. Using light pressure, insertion of the pin is continued. Once firm resistance of the second cortex is felt, six complete revolutions of the drill brace will put the pin tip through the second cortex (Fig 2).

Step 5:

Place second pin in the same limb/fragment. (Fig 3).

NOTICE

The larger the distance between these two pins the more stable the construct will be**

Step 6:

Attach one delta coupling to each pin***

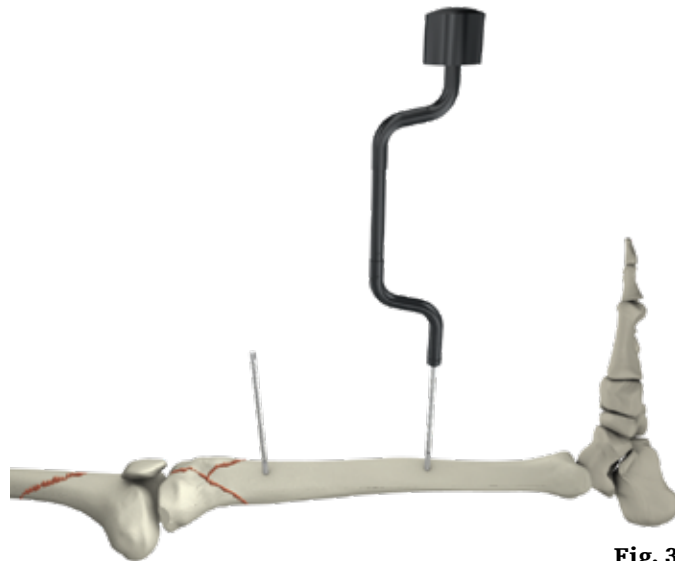

Fig. 3

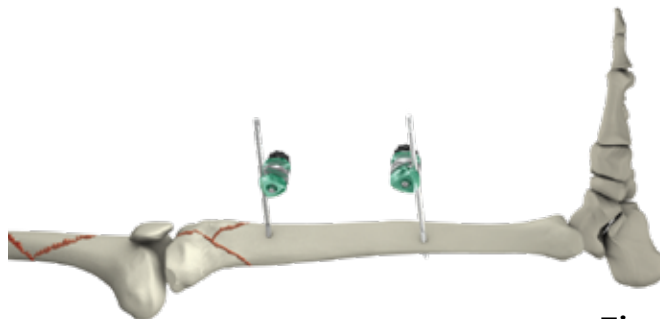

Fig. 4

**** Gernot Asche, Wolfgang Roth, Ludwig Schroeder (eds.):
The External Fixator - standard indications, operating instructions and examples of frame configurations; Markus Behrens: The mechanics and stability of fixator components. Page 32 ff.**

NOTICE

For increased stability follow the «rule of thumb»: «In» – «Up», meaning the delta couplings shall be «in» between the pins, the black thumbwheels looking «up» so that one has access to them for easy tightening.

Sterile field kit B

Step 7:

Attach a connecting bar to the delta couplings (Fig 5). Provisionally tighten the delta couplings using the built-in black thumbwheels by hand (Fig. 6).

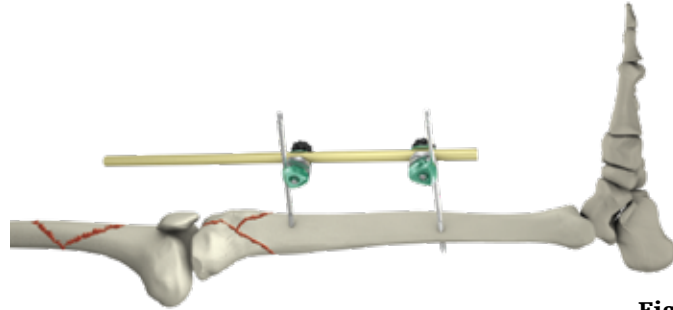

Fig. 5

Step 8:

Repeat this in the other limb and connect the two frames with 2 more couplings and a third bar to achieve a z-frame – here shown as a knee-bridging frame (Fig. 7). Before final tightening reduce and align the limbs as shown (Fig. 7).



Fig. 6

Step 9:

For final tightening remove the black thumbwheel from the coupling (Fig. 8).

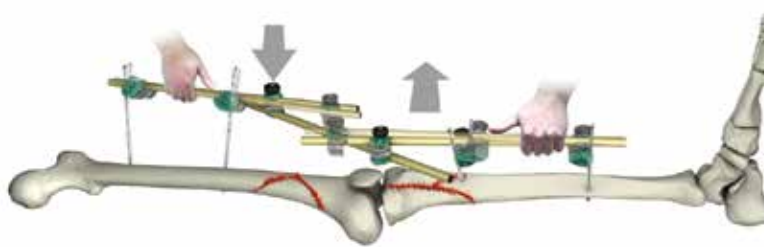

Fig. 7

Step 10:

Use the “clamp” end of the brace for final tightening while maintaining reduction and alignment of the limbs. Repeat for all delta couplings (Fig. 9).

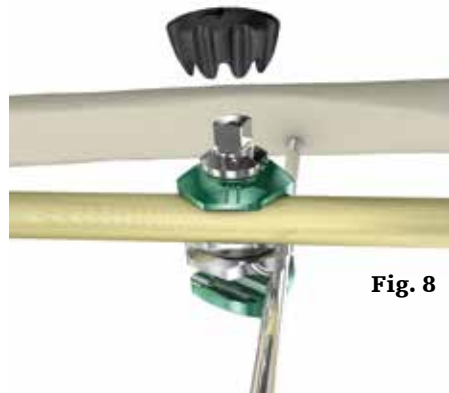

Fig. 8



Fig. 9

Sterile field kit B

**Knee bridging
frame example**



**Pelvic emergency
frame example**

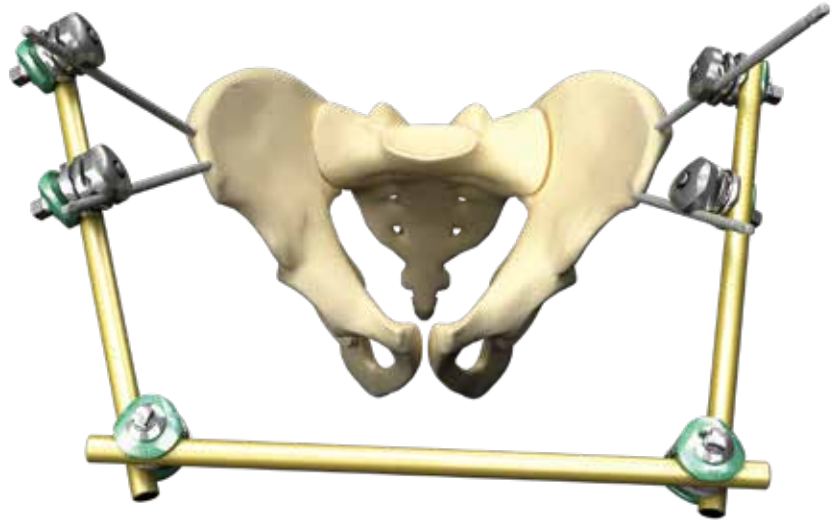

This document is intended solely for the use of healthcare professionals. A surgeon must always rely on his or her own professional clinical judgment when deciding whether to use a particular product when treating a particular patient. Stryker does not dispense medical advice and recommends that surgeons be trained in the use of any particular product before using it in surgery.

The information presented is intended to demonstrate a Stryker product. A surgeon must always refer to the product label and/or Instructions for Use, including the instructions for Cleaning and Sterilization (if applicable), before using any Stryker product. Products may not be available in all markets because product availability is subject to the regulatory and/or medical practices in individual markets. Please contact your Stryker representative if you have questions about the availability of Stryker products in your area.

The Instructions for Use, Operative Techniques, Cleaning instructions, patient information leaflets and other associated labeling may be requested online at www.ifu.stryker.com or www.stryker.com.

If saving the Instructions for Use, Operative Techniques, Cleaning instructions from the above mentioned websites, please make sure you always have the most up to date version prior to use.

Stryker Corporation or its divisions or other corporate affiliated entities own, use or have applied for the following trademarks or service marks: Apex, Hoffmann, Stryker. All other trademarks are trademarks of their respective owners or holders.

This document is applicable to US only.

Content ID: H-ST-20, Rev. 4, 03 - 2022

Copyright © 2022 Stryker



Manufacturer:

Stryker GmbH
Bohnackerweg 1
2545 Selzach
Switzerland

stryker.com