

Tornier Perform[®] Reversed Glenoid

Operative technique



This publication sets forth detailed recommended procedures for using Stryker devices and instruments. It offers guidance that you should heed, but, as with any such technical guide, each surgeon must consider the particular needs of each patient and make appropriate adjustments when and as required.

Important

- The patient should be advised that the device cannot and does not replicate a normal healthy bone, that the device can break or become damaged as a result of strenuous activity or trauma and that the device has a finite expected service life.
- Removal or revision of the device may be required sometime in the future.
- Cleaning and sterilization information is provided in the applicable instructions for use.
- Non-sterile devices, including implants and instruments, must be cleaned and sterilized prior to use, in accordance with validated methods.
- Devices that are able to be disassembled should be disassembled prior to point-of-use processing. Additionally, devices with movable components that do not facilitate disassembly should be manually articulated during the point-of-use processing step in order to evacuate additional soils.
- Please remember that the compatibility of different product systems has not been tested unless specified otherwise in the product labeling.
- Consult Instructions for Use (<https://ifu.stryker.com>) for a complete list of potential adverse effects and adverse events, contraindications, warnings and precautions.
- The surgeon must advise patients of surgical risks, and make them aware of adverse effects and alternative treatments.
- An implant whose packaging is open or damaged or whose expiration date has passed must not be used. Every precaution must be taken to ensure sterility when opening the packaging of the implant and during implantation.

Tornier Perform Reversed Glenoid

Table of contents

Overview	4
• Indications	4
• Contraindications	4
• Systems Compatibility	4
• Pre-operative planning	5
• Glenoid exposure	5
Surgical steps – cannulated technique	6
• Sizing the glenoid and pin placement	6
• Resurfacing the glenoid	7
• Baseplate post and central screw drilling.....	8
• Sizing for central screw.....	9
• Central screw tap.....	9
• Baseplate assembly and insertion.....	10
• Peripheral screw drilling and insertion	12
• Peripheral reaming	14
• Glenosphere trialing	14
• Final implantation	15
• Sphere insertion – ratcheting screwdriver and peripheral screwdriver bit	15
• Sphere insertion – cannulated glenosphere inserter	15
• Sphere impaction	16
Optional non-cannulated technique	17
• Initial drilling and resurfacing the glenoid	17
• Drilling for baseplate post and central screw	18
Baseplate lateralization	19
Tornier BIO-RSA supplementary steps	19
Press-fit post options.....	20
• Drilling for press-fit short post	20
• Drilling for press-fit long post	20
• Baseplate assembly and insertion.....	21
Baseplate revision.....	22
• Glenosphere and peripheral screw removal.....	22
• Baseplate loosening and central screw removal.....	23
Appendix	25
• Glenosphere and baseplate configuration chart.....	25
• Peripheral screw angulation	25
Instrumentation	26
Implants	31

Overview

Indications

The Tornier Perform Reversed Glenoid is indicated for use as a replacement of shoulder joints for patients with a functional deltoid muscle and with massive and non-repairable rotator cuff-tear with pain disabled by non-inflammatory degenerative joint disease (i.e. osteoarthritis and avascular necrosis), rheumatoid arthritis, traumatic arthritis, fractures of the humeral head, revision of the devices if sufficient bone stock remains or correction of functional deformity.

Contraindications

Absolute contraindications for shoulder arthroplasty are non-functional deltoid; paralysis of the axillary nerve; active local or systemic infection; sepsis and osteomyelitis; poor quality and insufficient quantity of glenoid bone stock; pre or peri-operative glenoid fracture; acromion fracture; elevation of sedimentation rate unexplained by other disease; elevation of WBC count, or marked shift in WBC differential count; significant injury to the upper brachial plexus.

Relative contraindications for shoulder arthroplasty are uncooperative patients or patients with neurologic disorders who are not capable of following directions; neuromuscular disease (e.g. joint neuropathy); osteoporosis; metabolic disorders which may impair bone formation; osteomalacia; distant foci of infections that may spread to the implant site; or rapid joint destruction, marked bone loss or bone resorption.

Systems Compatibility

The Tornier Perform Reversed Glenoid must be used in association with a compatible Stryker humeral component:*

- humeral implants Tornier Perform Humeral System, Aequalis Flex Revive Shoulder System and Tornier Flex Shoulder System in reverse configuration
- or humeral implants Aequalis Reversed, Aequalis Reversed FX or Aequalis Adjustable Reversed Shoulder System,
- or humeral implants Aequalis Reversed FX2

The Stryker shoulder prostheses are intended for replacement of the shoulder joint to reduce pain and improve shoulder mobility for patients with designated indication.

*Not all glenoid and humeral components are available in all geographies.

Pre-operative planning

Pre-operative planning is performed utilizing X-rays including a true anterior/posterior view of the glenohumeral joint or axillary views. The use of a CT scan or MRI is recommended to better determine the orientation of the glenoid, the quality of glenoid bone stock and to evaluate the integrity of the rotator cuff.

A careful analysis of X-rays and CT scan views is recommended before surgery to evaluate the following parameters: osteophytes, anterior, superior, posterior, and inferior wear of the glenoid, as well as the location, orientation and depth of the glenoid vault and presence of subcortical cysts.

If a bone graft is used during a primary surgery, or during a revision procedure with glenoid bone loss, it is recommended that an Tornier Perform Reversed Glenoid 29mm diameter baseplate be used in association with a centered glenosphere.

Glenoid exposure

Exposure of the glenoid is one of the more technically difficult aspects of shoulder arthroplasty. The size of the patient, soft tissue contractures, bony morphology, and the sequelae of previous surgeries are some of the potential challenges to adequate exposure. A thorough understanding of the neuroanatomy and techniques for protecting the axillary nerve, in particular, are routinely used to achieve successful exposure. In brief, a standard deltopectoral approach is typically used, with retraction of the deltoid laterally and pectoralis and conjoined tendon medially. A superior approach may also be utilized. Humeral exposure is performed per surgeon preference with appropriate subscapularis techniques and humeral head resection. The proximal humerus is then retracted posteriorly and access to the glenoid is gained. Residual labral tissue is excised, biceps tendon is released, and the capsule is released from the glenoid anteriorly, inferiorly, and posteriorly. Special attention is given for protection of the axillary nerve inferiorly. Appropriate glenoid retractors are then inserted and additional exposure techniques can be used as needed. Please reference the Tornier Approach Shoulder Arthroplasty Program for additional details.

Surgical steps – cannulated technique

Tornier Perform Reversed Glenoid Instrumentation allows for use of multiple surgical techniques to better suit the clinical situation and surgeon preference. The instrumentation allows for either a standard cannulated glenoid preparation referencing a guide pin positioned at a chosen orientation or a non-cannulated preparation.

Sizing the glenoid and pin placement

Two types of pin guides are available (circular or anatomic). | **Figure 1** The circular guide has the same outer diameter as the glenoid baseplate in 25mm or 29mm diameters. The anatomical pin guides come in four sizes (S=small, M=medium, L=large, and XL=extra-large) that correspond to the varying patient anatomies. The anatomical pin guides have an inferior offset built in, which positions the pin 12mm from the bottom of the guide¹. Two pin guide handles are offered in the instrument set, a 0° or 10° inferior tilt handle. The 0° pin guide handle can be used to prepare the baseplate perpendicular to the glenoid. The 10° pin guide handle can be used to place a 10° inferior tilt to the baseplate. The guides are assembled by rotating the distal end of the pin guide handle into the pin guide clockwise until it is fully seated. | **Figure 2**

According to surgeon preference, exposure, and surgical approach, the offset pin guide handle can be attached to the straight pin guide handles by sliding the offset handle down the shaft of the straight handle until it snaps in place. | **Figure 3** Use of the offset handle can provide better visualization as the guide pin is placed.

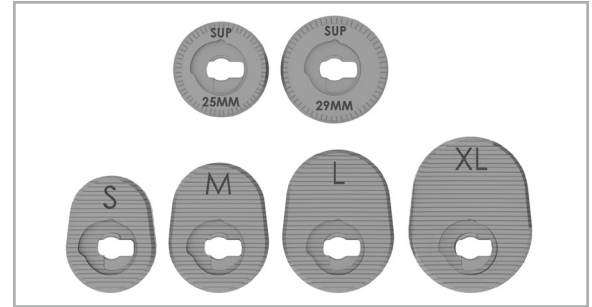

Figure 1

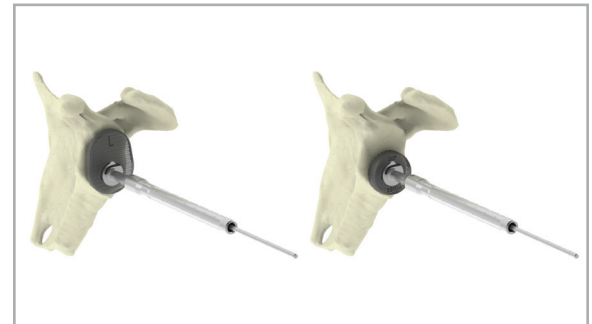

Figure 2



Figure 3

¹ Kelly, James D., C. Scott Humphrey, and Tom Norris. "Optimizing glenosphere position and fixation in reverse shoulder arthroplasty. Part One: The twelve-mm rule." *Journal of Shoulder and Elbow Surgery* 17.4 (2008): 589-594.

While referencing the face of the glenoid and appropriately seating the assembled pin guide on the inferior edge of the glenoid to reduce the risk of impingement, drill the 2.5mm guide pin through the guide pin handle until bi-cortical fixation is achieved. | **Figure 4**

Once the 2.5mm guide pin is fixed in the glenoid with bi-cortical fixation, remove the drill and the pin guide assembly. Finally, before reaming, check to ensure the guide pin is accurately placed on the glenoid and no adjustments are needed. It is important to check the guide pin condition after every step of the glenoid preparation. If the guide pin is damaged or bent, a new guide pin should be inserted.

Note: An optional trialing step to estimate glenoid position can be performed at this point using the guide pin and the glenosphere trials. | **Figure 5**

Resurfacing the glenoid

To obtain complete seating and secure fixation of the glenoid baseplate, it is important to create a flat glenoid surface using the cannulated baseplate reamer of the same diameter of the baseplate that will be used. Half-moon reamers are provided standard in the Tornier Perform Reversed Glenoid Instrument Set. If preferred, full-moon reamers are available upon request.

Connect the appropriate reamer to power and select the reaming option on the drill. Slide the assembly onto the guide pin and ream.

It is recommended to start the reamer before contacting the glenoid surface and ream until the glenoid surface is flat. | **Figure 6**

If insertion of the reamer is difficult, remove or reposition retractors for greater exposure. A T-handle is provided in all of Stryker's humeral instrument sets if manual reaming is desired. Preserve as much bone as possible to support good primary fixation while avoiding overly aggressive reaming to minimize the risk of glenoid fracture.

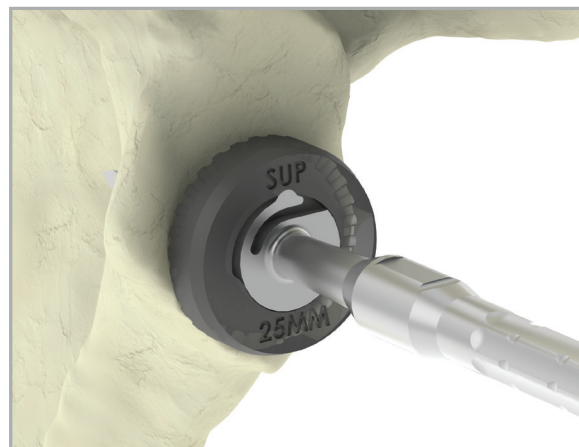

Figure 4

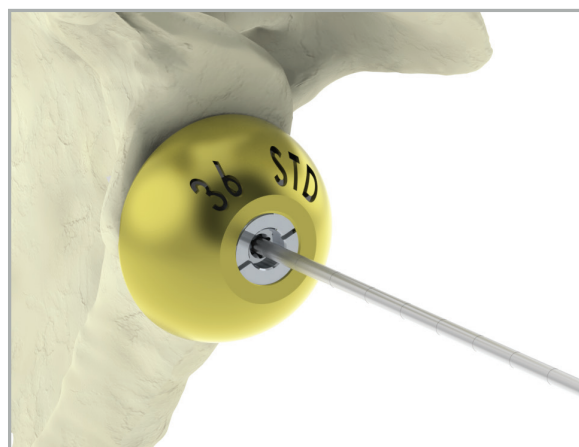

Figure 5



Figure 6

Baseplate post and central screw drilling

The hole for the baseplate post is drilled over the guide pin using the cannulated 10mm diameter drill bit. A positive stop on the drill bit ensures that drilling will not go too deep and allows for press-fit fixation of the post. | **Figure 7**

Remove the guide pin.

The surgeon determines the diameter of the central screw drill bit based on patient bone quality. It is recommended to start with the 6.5mm diameter drill bit as the hole can be expanded if necessary. 9.5mm diameter screws are recommended if inadequate fixation is achieved with a 6.5mm diameter screw secondary to poor bone quality or for revision cases.

Place the corresponding central screw drill and central drill guide into the hole in the glenoid face that was created using the baseplate post drill. The central screw hole is drilled using a 6.5mm or 9.5mm diameter drill bit. Laser marks can be used to approximate the final implant length.

| **Figure 8A and 8B**

The drilling is performed under power. Palpation of the drill bit tip can be performed to confirm the drill bit has exited the anterior cortex.

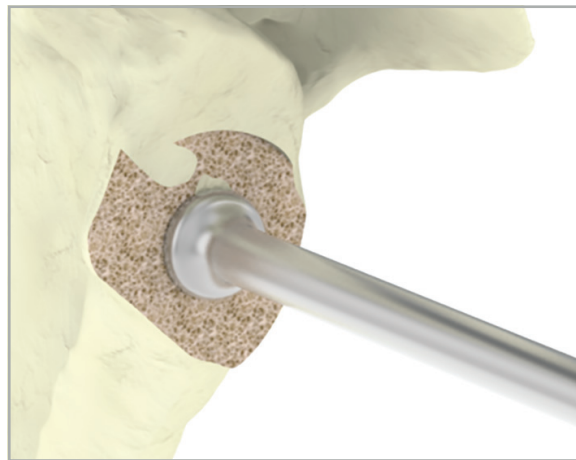

Figure 7

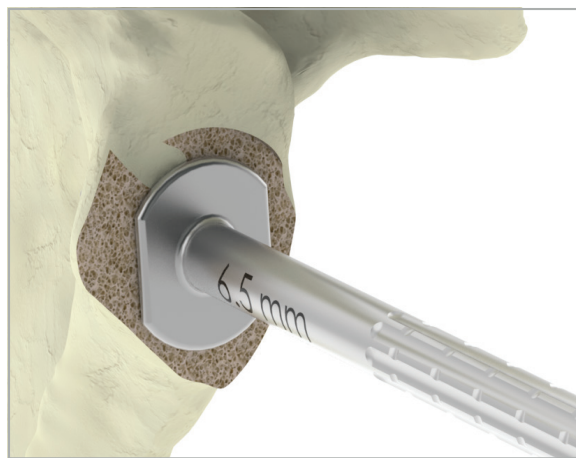

Figure 8A



Figure 8B

Sizing for central screw

To determine the final central screw length, the central screw depth gauge is used. | **Figures 9A and 9B** The gauge measures the recommended screw length. The actual prepared hole is approximately 3mm less to allow for bicortical fixation.

To ensure an accurate evaluation of the final screw length, make sure the flat end of the depth gauge is contacting the glenoid surface.

The length of the central screw is matched with the color and number that appears on the depth gauge. If you fall on a line above a color, choose the length above the line.

Note: If the gauge measures between two lengths, pick the screw length that is shown. (**Figure 9A:** the depth gauge reads in the middle of the green/30mm band, choose the 30mm central screw).

Central screw tap

Although the central screws are self-tapping, after measuring the depth of the central hole, the tap can be used to prepare the threads of the final implant and reduce the possibility of glenoid fracture in cases for hard bone. Tapping is recommended when using the 9.5mm central screw in order to prevent glenoid fracture.

Tapping should be done manually by connecting it to a T-handle (Do not use with power). When tapping, it is important to maintain alignment to the axis of the previously drilled hole. There are laser markings on the tap to show depth. | **Figures 10A and 10B** The tapping depth should be chosen similar to the depth of the drilled central hole. Using the measurements of the central screw length, stop at the level of the corresponding laser mark.



Figure 9A



Figure 9B

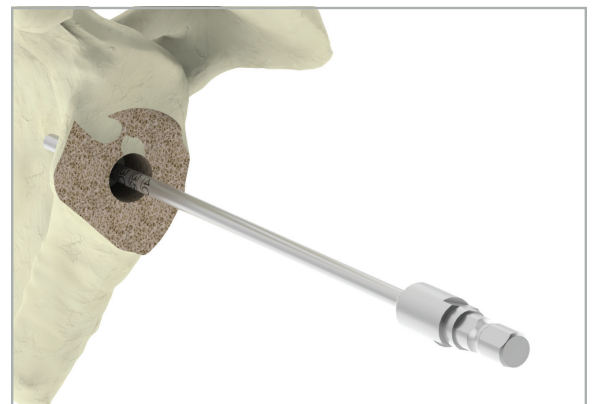

Figure 10A

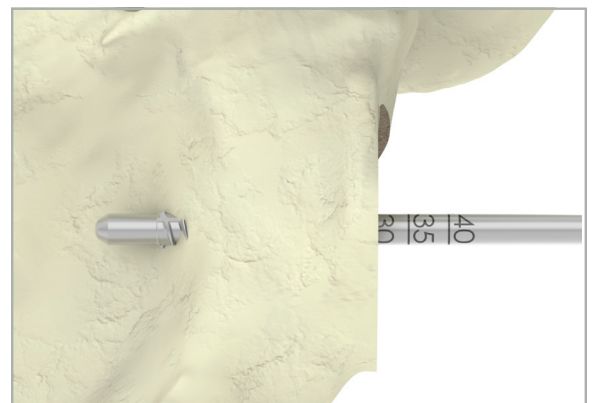

Figure 10B

Baseplate assembly and insertion

The final baseplate is chosen according to the reamed glenoid surface (25mm or 29mm). Additionally, the final central screw is chosen according to the measured length using the central screw depth gauge.

Ensure that the inner shaft of the baseplate inserter is backed out to the point where it moves freely within the outer sleeve yet is still contained. While lining up the pegs on the inserter with the peg holes on the baseplate, snap the inserter onto the baseplate. Screw the inner shaft down the sleeve to capture the baseplate onto the inserter. Care should be taken to ensure that the two pegs on the inserter seat properly into their respective holes on the baseplate. | **Figures 11A and 11B**

There is a 6.5mm and 9.5mm slot corresponding to the screw diameter. The hex head portion of the screw is orientated in the up position.

| **Figure 12**

The baseplate inserter with baseplate attached is placed onto the screw and turned in a counterclockwise manner. | **Figure 13** Turn the baseplate until it is fully seated onto the screw. There will be a slight drop of the baseplate indicating that it has fully seated. The baseplate will spin independently from the screw once seated. The baseplate/screw can be removed from the assembly tool.

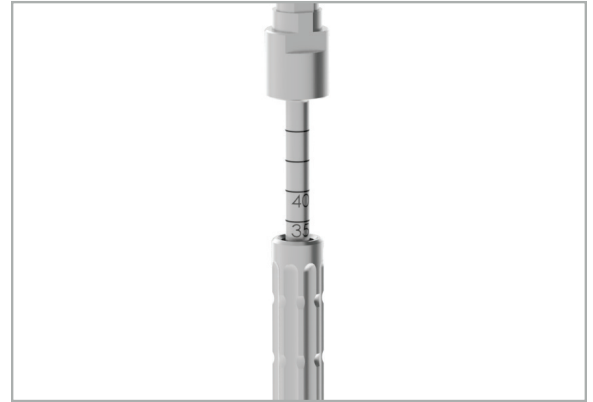

Figure 11A



Figure 11B

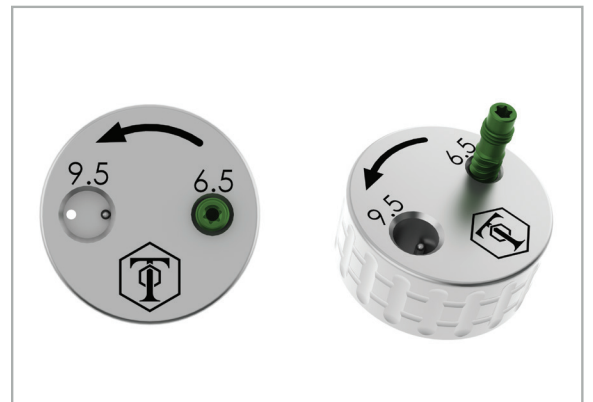

Figure 12

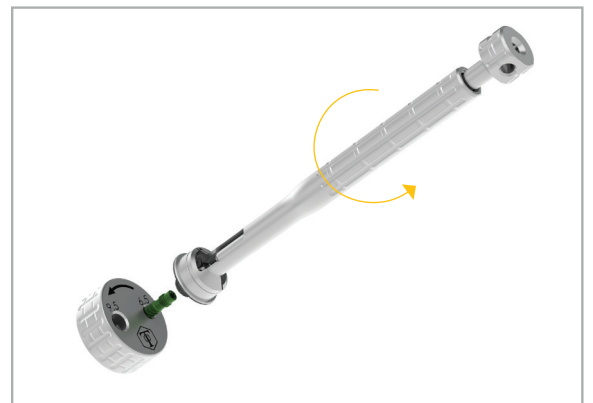

Figure 13

Insert the baseplate inserter screwdriver down the shaft of the baseplate inserter and engage the head of the central screw. To insert the assembled baseplate, place the screw into the central screw drill hole and turn the central screw in a clockwise manner. | **Figure 14** It is important to continuously check the orientation of the baseplate relative to the prepared hole and reamed surface to ensure accurate implantation of the baseplate. Screw the baseplate into the prepared glenoid until it has fully seated against the surface. There will be a slight audible clicking noise once the post begins to engage the prepared bone. This is normal and is due to the free-floating nature of the screw within the assembly.



Figure 14

Note: At the completion of glenoid component installation, the central locking screw of the glenosphere locks the central compression screw into the baseplate, creating a locked fixed angle implant.

An arrow on the baseplate inserter will indicate your superior or inferior screw hole. Once the baseplate is seated flush on the glenoid surface, the baseplate inserter can be detached from the baseplate.

Note: The baseplate should be seated completely onto the prepared glenoid surface. Avoid over-tightening or excessive advancement of the baseplate into the subchondral bone. Gaps between the baseplate and glenoid surface should also be avoided.

Note: If the 6.5mm screw strips a 9.5mm screw can be used. This is accomplished by removing the baseplate and installing the 9.5mm screw in place of the 6.5mm screw.

Peripheral screw drilling and insertion

Once the baseplate is implanted, the four peripheral holes are prepared using the 3.2mm diameter drill bit and the peripheral screw drill guide. | **Figure 15**
The standard and lateralized baseplates contain two multidirectional locking screws that can be placed in the desired location. The angles of the multidirectional locking screws can be found in the Appendix. The direction of the drill axis is chosen by free orientation of the drill guide. The other peripheral screw holes are fixed compression screws and have no angle variability. These will be put in on-axis to the central screw.

The 3.2mm diameter drill bit is passed through the guide and the hole is drilled bicortically. It is desirable to have the superior screw in the base of the coracoid and the inferior screw in the pillar of the scapula, where the best bone fixation of the screws can be achieved. With inferior positioning of the baseplate, the inferior screw is frequently placed parallel to the central screw.

It is important to avoid angling the drill guide and drilling too close to the post in order to avoid any damage to the post and compromising fixation. The screw length can be read directly from the end of the drill guide by locating the laser mark on the drill. | **Figure 16**

Note: On the standard and lateralized baseplates, the anterior and posterior holes are fixed and used for compression and can be considered optional when using a central screw. If the press-fit post option is desired it is recommended to use all four peripheral holes.

Note: When using the lateralized baseplates, longer peripheral screws are required to account for the augmented offset from the bone. A minimum peripheral screw length of 26mm should be used for the superior and inferior screw holes to ensure sufficient bone purchase.

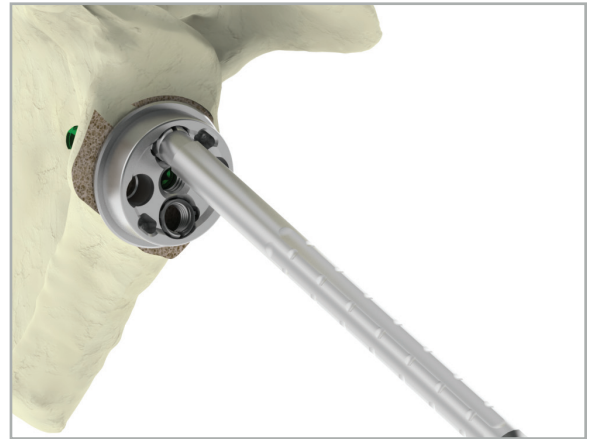

Figure 15

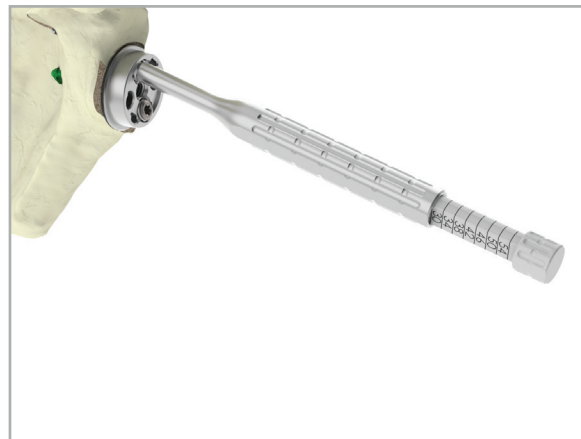
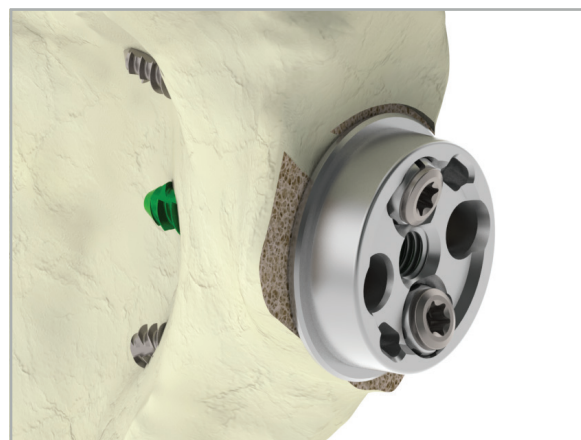

Figure 16

Measure the depth of the drilled peripheral screw hole using the peripheral screw depth gauge. | **Figure 17** Insert the distal end of the depth gauge in the screw hole that was drilled on the baseplate. Insert the thin wire portion of the depth gauge into the prepared hole and with the L-shaped distal portion, hook the distal portion of the drilled hole. The length of the peripheral screw is matched with the number that appears on the depth gauge. If you fall on a line above a number, choose the length below the line.

The peripheral screws act as both locking and compression screws and therefore may go in the fixed angle or multidirectional prepared holes. After measuring each hole, attach the peripheral screwdriver bit onto the ratcheting screwdriver (the baseplate inserter screwdriver can also be used at this step). The peripheral screws are inserted into the drilled holes and hand tightened. | **Figure 18**

The baseplate implantation is finalized once all screws are seated.
| **Figure 19**

**Figure 17****Figure 18****Figure 19**

Peripheral reaming

The peripheral reamer associated with the corresponding diameter of the intended glenosphere is attached to a T-handle. Do not use these reamers under power.

Reaming with the peripheral reamers must be performed manually and kept parallel to the central screw. The pilot tip on the reamer is carefully inserted into the central hole of the baseplate in alignment with the axis of the baseplate post. | **Figure 20** Manual reaming is then performed using a back-and-forth sweeping motion. | **Figure 21** Progression of the reaming should be gradual, being careful not to ream too aggressively to cause glenoid fracture.



Figure 20

Glenosphere trialing

To allow for trialing of the glenoid with the humeral components, the optional glenosphere trials can be obtained. Place the desired size glenosphere onto the baseplate and tighten the screw with the screwdriver. | **Figure 22**

Four different sizes of glenospheres are available in 33mm, 36mm, 39mm and 42mm in the following configurations:

- a. Centered glenospheres (standard)
- b. Inferior offset eccentric glenosphere (+2 for the 36mm; +3 for the 39mm and +4 for the 42mm)
- c. Lateralized glenosphere (to create 3mm of lateralization)

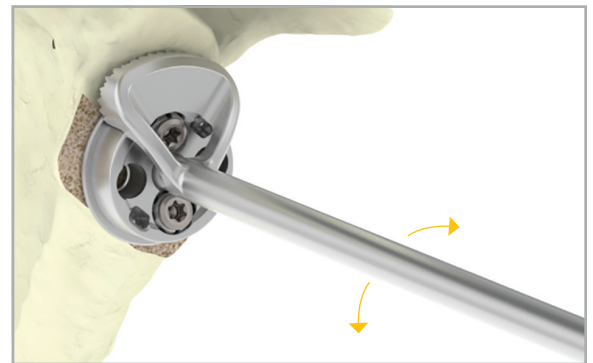

Figure 21

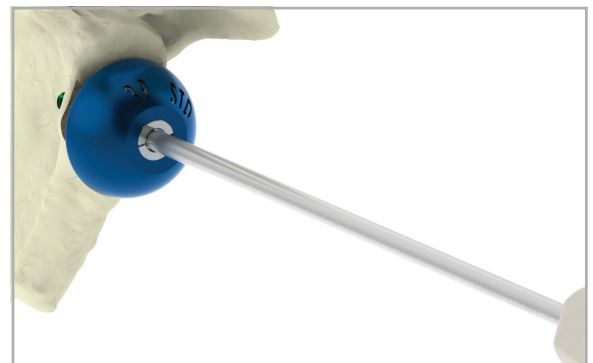

Figure 22

Final implantation

Once the desired sphere is chosen, the final implantation can be performed. Prior to positioning of the definitive glenosphere, it is important to remove any soft tissue between the baseplate and the glenoid sphere. Attach the peripheral screwdriver bit to the ratcheting screwdriver. Insert the driver tip and engage the locking screw captured in the glenosphere, turn it counterclockwise until it stops.

Assemble the glenosphere impactor tip onto the impactor handle from the humeral instrument set.

Note: The 33mm glenosphere should only be used with the 25mm baseplate and is only offered in the +3mm lateralization option.

Sphere insertion – ratcheting screwdriver and peripheral screwdriver bit

Using the ratcheting screwdriver and peripheral screwdriver bit, engage the locking screw captured in the glenosphere. Place the glenosphere onto the baseplate using the screwdriver | **Figure 23**, engage the morse taper. Do not impact the ratcheting screwdriver and peripheral screwdriver bit.

Sphere insertion – cannulated glenosphere inserter

On the handle of the cannulated glenosphere inserter, depress and lock the thumb slide to extend the glenosphere tip. Engage the glenosphere tip of the cannulated glenosphere inserter into the captured screw opening on the glenosphere | **Figure 24A**. Pass the nitinol guide wire through the cannulated glenosphere inserter, extending the nitinol guide wire out the backside of the glenosphere | **Figure 24B**. Once the nitinol guide wire has passed out the backside of the glenosphere, the glenosphere is locked onto the cannulated glenosphere inserter. Unlock the thumb slide on the cannulated glenosphere inserter | **Figure 24C**.

Note: To ensure that the articulating surface is not damaged during assembly, avoid contact between the glenosphere inserter tip and the glenosphere articulating surface.

Engage the nitinol guide wire into the central feature in the baseplate. Slide the glenosphere down the nitinol guide wire towards the baseplate, engaging the morse taper | **Figure 25**. Remove the nitinol guide wire and lightly strike the impaction surface of the cannulated glenosphere inserter to initiate engagement of the morse taper. Move the thumb slide towards the impaction surface of the cannulated glenosphere inserter to disengage the glenosphere tip.



Figure 23



Figure 24A, Figure 24B, Figure 24C

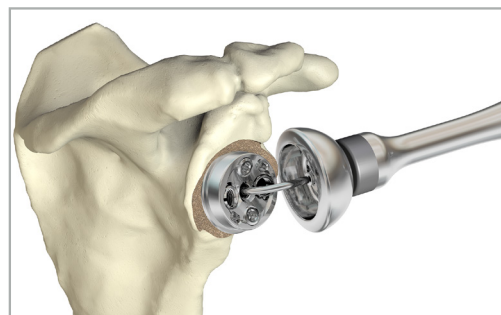

Figure 25

Sphere impaction

The glenosphere is then impacted onto the morse taper of the glenoid baseplate with the glenosphere impactor assembly | **Figure 26**. There will be a 2 mm gap between the glenoid face and the glenosphere.

The fixation of the assembly is visually checked to ensure that no soft tissue is present between the baseplate and glenosphere. Once impacted, secure the assembly by tightening the glenosphere locking screw clockwise with the ratcheting screwdriver and the peripheral screwdriver bit. Increased resistance will be felt when engaging the spring lock washer in the glenosphere. Continue tightening until the glenosphere central locking screw is fully seated using hand pressure only.



Figure 26

Optional non-cannulated technique

Initial drilling and resurfacing the glenoid

The non-cannulated drill guide is the same outer diameter as the final glenoid baseplate (25mm or 29mm). Choose the appropriate diameter drill guide that matches the desired final baseplate diameter.

According to surgeon preference, exposure, and surgical approach, the drill guide is positioned making sure that its bottom surface is properly seated on the bone surface. To limit any risk of impingement, it is important to properly align the drill guide with the inferior edge of the glenoid. When evaluating the central hole location and angle of entry for eroded glenoids, the hole orientation and angle of entry may need to be adjusted to compensate for wear. Referencing the pre-operative CT scan or MRI, the central hole is typically located inferiorly and slightly posterior from the anatomical center.

Insert the 6.5mm diameter central screw drill into the drill guide and drill until the far cortex is reached. | **Figure 27**

To obtain good bone seating and secure fixation of the glenoid baseplate it is important to flatten the glenoid surface. Two non-cannulated baseplate reamers for diameters 25mm or 29mm are available to create the flat surface for the glenoid baseplate.

Attach the reamer to power making sure that the drill is on ream. Once attached, insert the tip of the reamer into the pilot hole of the glenoid. It is recommended to start the reamer before contacting the glenoid surface and ream until the glenoid surface is flat. | **Figure 28**

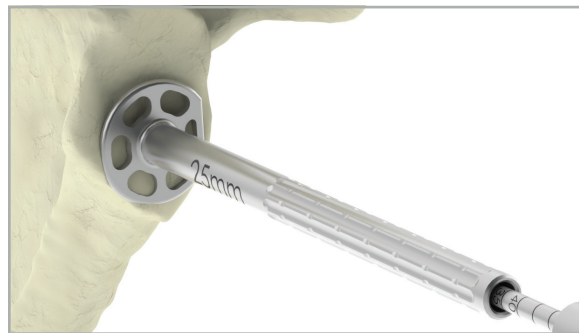

Figure 27

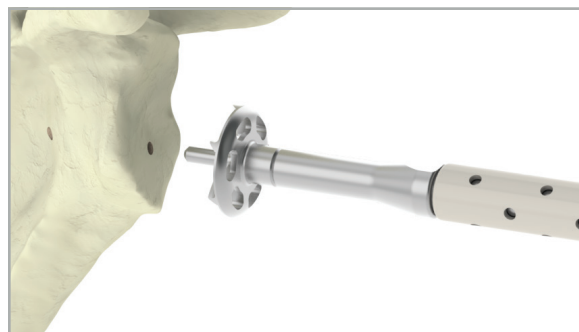

Figure 28

Once the reamer tip is inserted into the drill hole, apply power to the reamer prior to seating on the glenoid surface and then apply using pressure. The reamer should remain perpendicular to the pilot hole. The goal of reaming is to obtain a bony surface that matches the backside of the glenoid component. However, it is not advisable to ream down to cancellous bone because of the limited glenoid bone stock.

Note: Over-aggressive reaming should be avoided to prevent possible glenoid fracture. | **Figure 29**

Drilling for baseplate post and central screw

The hole for the baseplate post is drilled using the non-cannulated 10mm diameter baseplate post drill. A positive stop on the drill bit maintains that drilling will not go too deep and ensures a press-fit fixation for the post.

| **Figure 30**

If it is desired to use a 9.5mm central screw, insert the 9.5mm central screw guide into the post hole. Attach the 9.5mm central screw drill bit to power and drill until the far cortex is reached.

Note: Please refer to figures 8a – 26 of the above technique to complete the procedure.

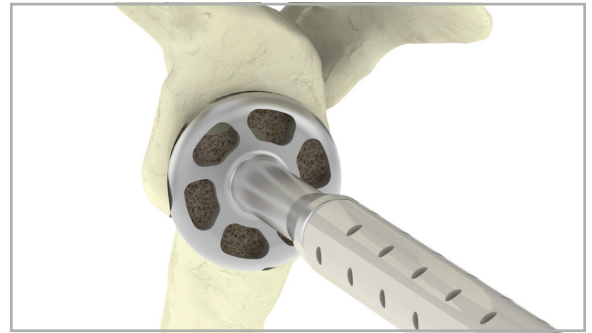

Figure 29

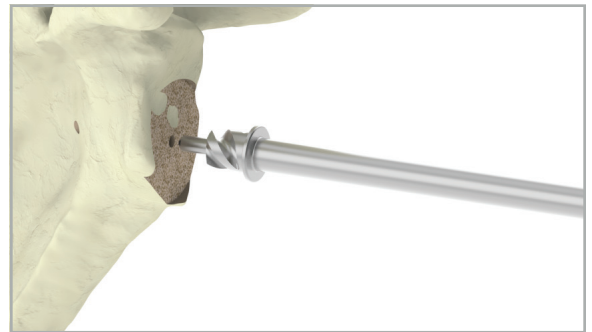

Figure 30

Baseplate lateralization

The Tornier Perform Reversed Glenoid Baseplates provide lateralization of the glenoid component.

The baseplate achieves lateralization using Stryker's Adaptis Integrated Porous Metal Technology that was designed to encourage bone ingrowth. Stryker offers the following baseplates to achieve lateralization:



25mm with +3mm lateralization



25mm with +6mm lateralization



29mm with +3mm lateralization



29mm with +6mm lateralization

There is no difference in the operative technique for the lateralized baseplates. Please refer to the standard cannulated or non-cannulated technique above.

Tornier BIO-RSA supplementary steps

If it is desired to utilize Stryker's Tornier BIO-RSA technology please refer to the operative technique that is provided with that instrument set.

Warning: Tornier BIO-RSA operative technique is not recommended to be used: in cases of severe glenoid bone deficiency, not autologous humeral head bone graft, humeral head necrosis, revision of failed hemi or total arthroplasty and humeral head fractures.

Note: Do not to use the Tornier BIO-RSA bone graft with the lateralized augmented baseplates.

Note: A separate drilling step must be performed in order to have the bone graft fit to the standard baseplates. After the bone graft is produced, the surgeon must use the 10mm diameter baseplate post drill to drill both sides of the bone graft. This must be done in order for the graft to fit onto the baseplate post.

Press-fit post options

The initial glenoid preparation is the same for the press-fit post option. Please refer to pages 6-8 for cannulated technique or pages 17-18 for non-cannulated technique. After these steps, perform the following:

Drilling for press-fit short post

Final drilling of the glenoid central hole is performed under power using the press-fit short post drill to enable a press-fit when impacting the final glenoid baseplate (the baseplate post has a diameter of 11mm).

Attach the press-fit short post drill to power and drill over the guide pin to prepare for the baseplate. Drill until the depth stop contacts the surface of the glenoid bone. | **Figure 31** The press-fit short post drill is designed to drill the hole for the baseplate post and 7mm press-fit post in a single step. A positive stop on the drill bit ensures that drilling will not go too deep and allows for press-fit fixation of the baseplate post. Remove the drill bit.

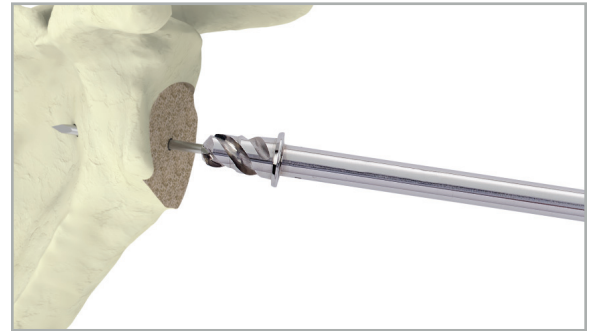

Figure 31

Drilling for press-fit long post

Final drilling of the glenoid central hole is performed under power using the 8mm diameter press-fit post drill to enable a press-fit when impacting the final glenoid baseplate (the baseplate post has a diameter of 11mm).

Attach the 8mm diameter press-fit post drill to power and drill into the prepared hole in the glenoid. Drill until the depth stop contacts the surface of the glenoid bone. | **Figure 32** The hole for the baseplate post is drilled over the guide pin using the cannulated 10mm diameter drill bit. A positive stop on the drill bit ensures that drilling will not go too deep and allows for press-fit fixation of the baseplate post. Remove the drill bit.

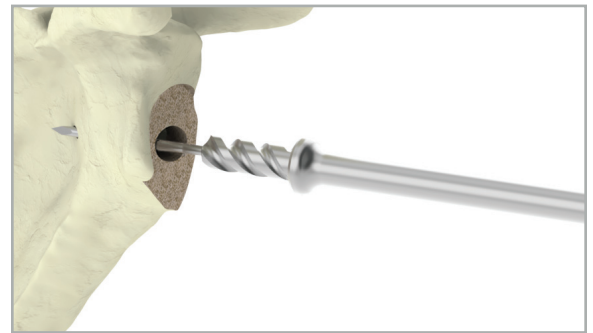

Figure 32

Baseplate assembly and insertion

The final baseplate is chosen according to the reamed glenoid surface (25mm or 29mm).

The baseplate is then attached to the baseplate inserter in the same manner as on page 10 from above.

The central post is attached by hand to the baseplate by screwing it onto the baseplate in a counterclockwise motion. | **Figure 33** The post must be securely screwed onto the baseplate. To achieve a secure attachment, insert the baseplate inserter screwdriver down the shaft of the baseplate inserter and engage the head of the post. In a clockwise motion, tighten the post to the baseplate. | **Figure 34**

To insert the assembled baseplate, place the post into the prepared hole and using a mallet, gently impact the baseplate into the glenoid until it has fully seated against the surface. Once the baseplate is seated flush on the glenoid surface, the baseplate inserter can be detached from the baseplate. The baseplate should be seated completely onto the prepared glenoid surface. Gaps between the baseplate and glenoid surface should be avoided.

Please refer to pages 12-16 of the cannulated technique above to complete the procedure.



Figure 33

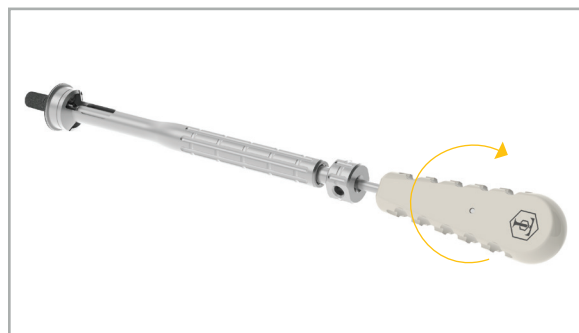

Figure 34

Baseplate revision

Glenosphere and peripheral screw removal

Please refer to the following steps if removal of the implants is necessary.

After exposing the glenosphere, attach the sphere screwdriver bit onto the ratcheting screwdriver handle. Insert the screwdriver bit into the screw on the glenosphere and turn counterclockwise. | **Figure 35** Unscrew the locking screw until it backs out completely to ensure that it is not engaged to the baseplate. When doing this, it is suggested applying slight downward pressure on the locking screw and continuing to unscrew until you feel the locking screw clicking. This ensures that the screw is fully backed out of the baseplate.



Figure 35

To remove the sphere from the baseplate, make sure the glenosphere extractor has the central locking screw backed out completely. Insert the tip of the extractor into the central screw hole on the glenosphere at a slight angle to ensure ease of insertion. Once the tip of the extractor has been inserted into the hole of the glenosphere, angle the extractor so that it becomes axially aligned with the implants. Staying parallel with the central screw, begin to turn the central post down the extractor shaft by turning the knob in a clockwise motion. The glenosphere will then be released from the baseplate. | **Figures 36A and 36B**



Figure 36A



Figure 36B

Note: Do not use impaction force with this instrument.

If the glenosphere does not remove on the first attempt, remove the extractor and check to ensure that the locking screw is fully backed out of the baseplate.

To remove the peripheral screws from the baseplate, attach the peripheral screw bit to the provided ratcheting screwdriver. Remove each screw one at a time.

Baseplate loosening and central screw removal

To loosen the baseplate from the glenoid, attach the baseplate revision tool to a T-handle. Insert the two pegs on the baseplate revision tool into opposing peripheral screw holes and turn with hand power only. Turn using a gentle oscillating motion to loosen the baseplate from the glenoid. Avoid turning in a clockwise motion to prevent inserting the assembly further into the glenoid. | **Figures 37A and 37B**

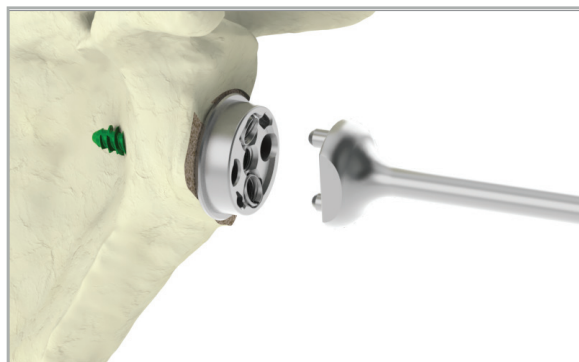

Figure 37A

Once the baseplate is loosened from the glenoid surface, place the baseplate inserter onto the baseplate, lining up the pegs on the baseplate inserter with the peg holes on the baseplate. Screw the shaft down the holder to capture the baseplate onto the inserter. Care should be taken to ensure that the two pegs on the inserter seat properly into their respective holes on the implanted baseplate.

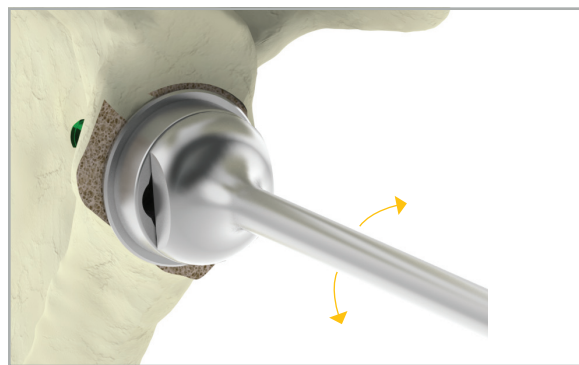

Figure 37B

Insert the baseplate inserter screwdriver down the shaft of the baseplate inserter and engage the head of the central screw. Insert the baseplate screwdriver into the baseplate holder. To remove the assembled baseplate, screw in a counterclockwise motion. Unscrew the baseplate until it is fully removed from the glenoid. | **Figure 38**

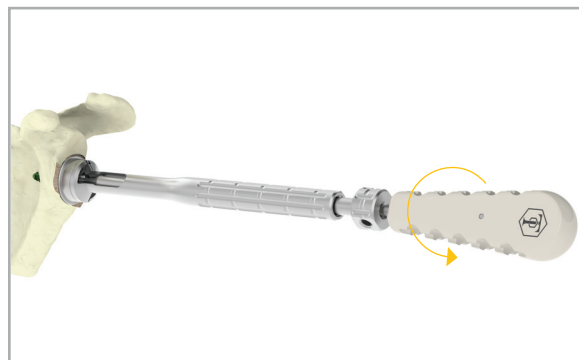

Figure 38

Note: Intra-operative removal of a central screw from an implanted Tornier Perform Reversed Baseplate is not advised, as it may be difficult to unscrew from the baseplate. Introducing a central screw into a baseplate creates a compressive engagement force, which—upon implantation—may make attempts at central screw removal problematic. It is advised to confirm proper screw length **prior** to implantation.

If a central screw change needs to be made, please follow the steps below to properly excise/extract the implant. If the central screw does not disengage from the baseplate, a new baseplate with the correct length central screw will need to be implanted.

Step 1: Ensure the baseplate inserter handle [MWJ118] is attached to the baseplate.

- **Do not use the central screw assembly tool [MWJ163]**

Step 2: Apply downward pressure with the baseplate inserter screwdriver [MWJ123] and turn the baseplate inserter screwdriver counter-clockwise until the screw falls out. | **Figure 39**

- You may encounter some resistance, however continue turning until the screw threads out of the baseplate.

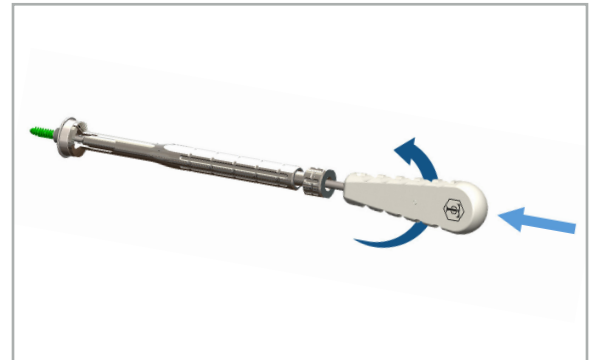

Figure 39

Appendix

Tornier Perform Reversed Glenoid Glenosphere and Baseplate configuration chart

The Tornier Perform Reversed Glenoid Baseplates have been designed to be compatible with the Tornier Perform Reversed Glenoid Glenospheres. With the addition of the Adaptis Integrated Porous Metal on the backside of the baseplate, certain combinations may have the potential to create an impingement with the humeral insert. For more information on the cleared combinations, refer to the configuration chart below. The boxes highlighted in green indicate that there should be no impingement of the poly insert on the humeral side with the porous titanium on the baseplate.

Glenosphere		Baseplate					
		Standard		Lateralized			
		25mm	29mm	25mm (+3)	29mm (+3)	25mm (+6)	29mm (+6)
Standard	36mm						
	39mm						
	42mm						
Eccentric	36mm +2 ECC						
	39mm +3 ECC						
	42mm +4 ECC						
Lateralized	33mm +3 LAT						
	36mm +3 LAT						
	39mm +3 LAT						
	42mm +3 LAT						

 Cleared combination  Not cleared combination

Tornier Perform Reversed Glenoid Peripheral Screw angulation

Baseplate	Multidirectional locking screws		Compression screws	
	Superior - Inferior	Transverse	Superior - Inferior	Transverse
Standard baseplate	0-25°	±12°	0°	3°
Lateralized baseplate (+3mm)	0-25°	±9°	0°	3°
Lateralized baseplate (+6mm)	0-25°	±7°	0°	3°

Instrumentation

Tray upper level

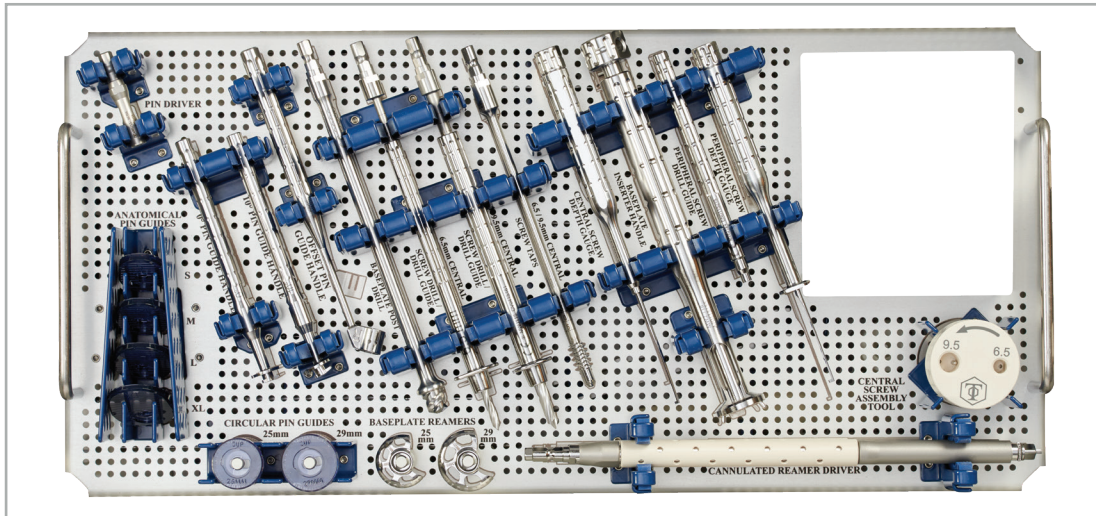

Tornier Perform Reversed Glenoid Standard Instrument Tray upper level (Ref. YKAD261)

Reference	Description
MWB253	Pin driver
MWE151	Cannulated reamer driver
MWJ101	Circular pin guide, 25mm
MWJ102	Circular pin guide, 29mm
MWJ103	Anatomical pin guide, s
MWJ104	Anatomical pin guide, m
MWJ105	Anatomical pin guide, l
MWJ106	Anatomical pin guide, xl
MWJ107	Pin guide handle, 0°
MWJ108	Pin guide handle, 10°
MWJ109	Half moon baseplate reamer, 25mm
MWJ110	Half moon baseplate reamer, 29mm
MWJ113	Baseplate post drill, 10mm
MWJ111	Central screw drill, 6.5mm
MWJ112	Central screw drill, 9.5mm
MWJ114	Central screw drill guide, 6.5mm
MWJ115	Central screw drill guide, 9.5mm
MWJ116	Central screw depth gauge
MWJ121	Central screw tap, 6.5mm
MWJ122	Central screw tap, 9.5mm
MWJ118	Baseplate inserter handle
MWJ124	Peripheral screw drill guide
MWJ125	Peripheral screw depth gauge
MWJ163	Central screw assembly tool
MWJ117	Offset pin guide handle

Tray lower level

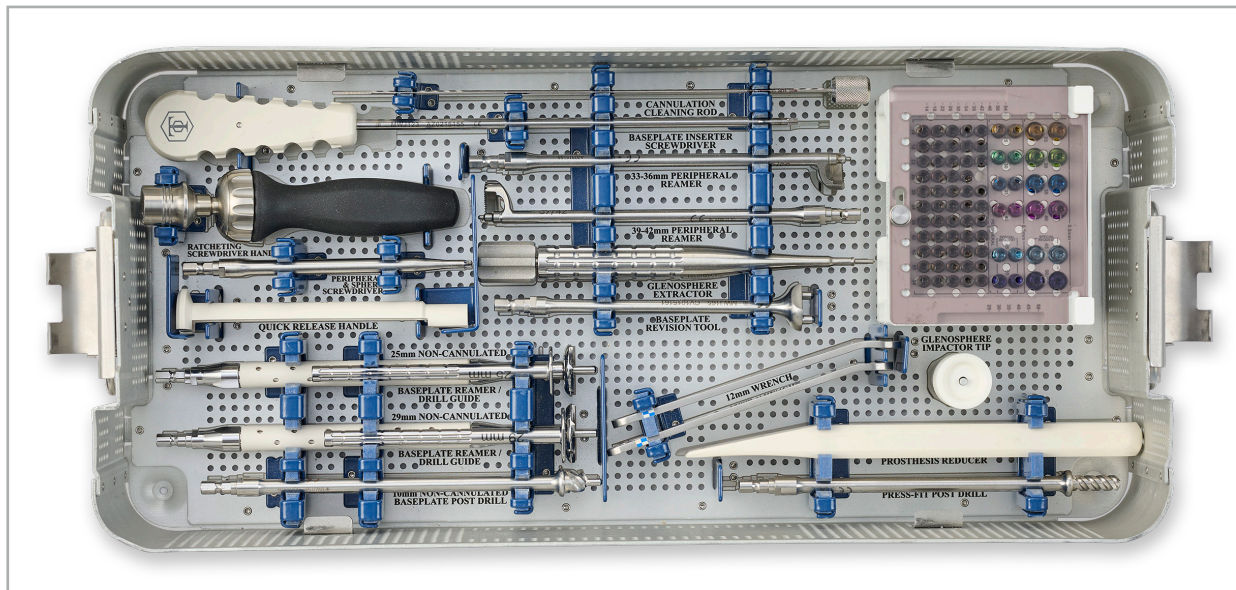

Tornier Perform Reversed Glenoid Standard Instrument Tray lower level (Ref. YKAD261)

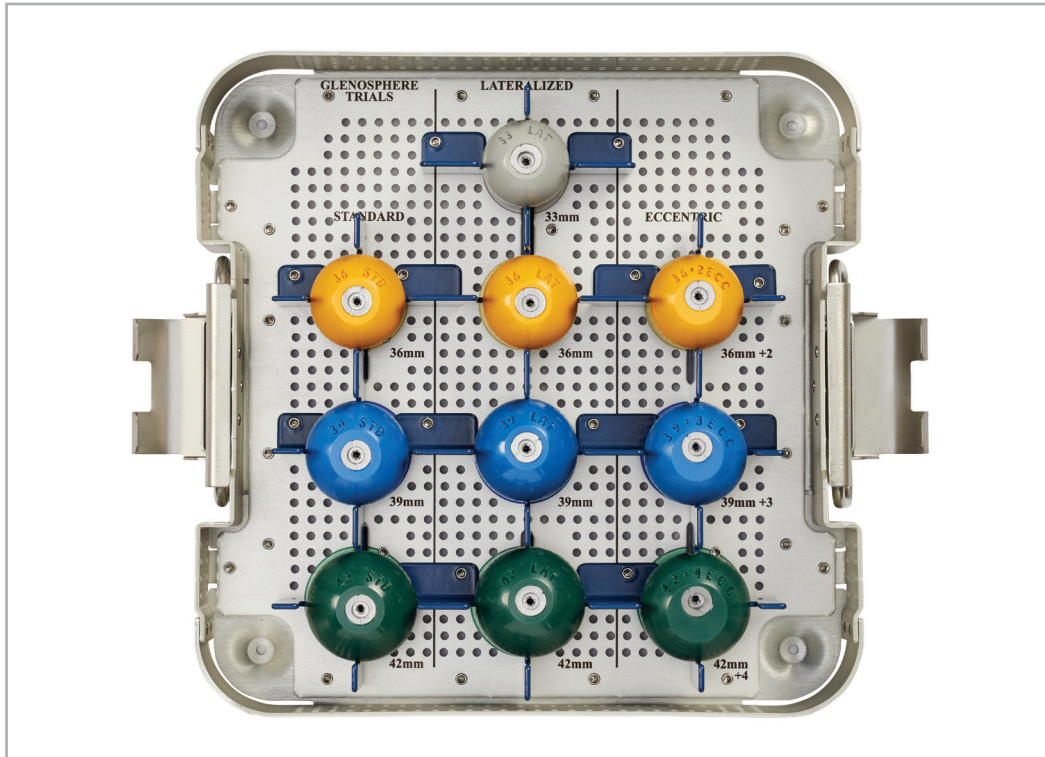
Reference	Description
MWB236	Cannulation cleaning rod
MWD552	12mm wrench
MWD425	Glenosphere impactor tip
MWE158	Quick release handle
MWJ100	Prosthesis reducer slim
MWJ123	Baseplate inserter screwdriver, t20
MWJ119	Peripheral reamer, 33-36mm
MWJ120	Peripheral reamer, 39-42mm
MWJ127	Peripheral and sphere screwdriver bit, t20
MWJ196	Non-cannulated ratcheting screwdriver handle
MWJ130	Glenosphere extractor
MWJ165	Baseplate revision tool
MWJ162	Press-fit post drill, 15mm
MWJ180	Screw caddy
MWJ149	Non-cannulated baseplate reamer, 25mm
MWJ150	Non-cannulated baseplate reamer, 29mm
MWJ158	Non-cannulated baseplate post drill, 10mm
MWJ159	Non-cannulated 4.0mm drill guide, 25mm
MWJ160	Non-cannulated 4.0mm drill guide, 29mm

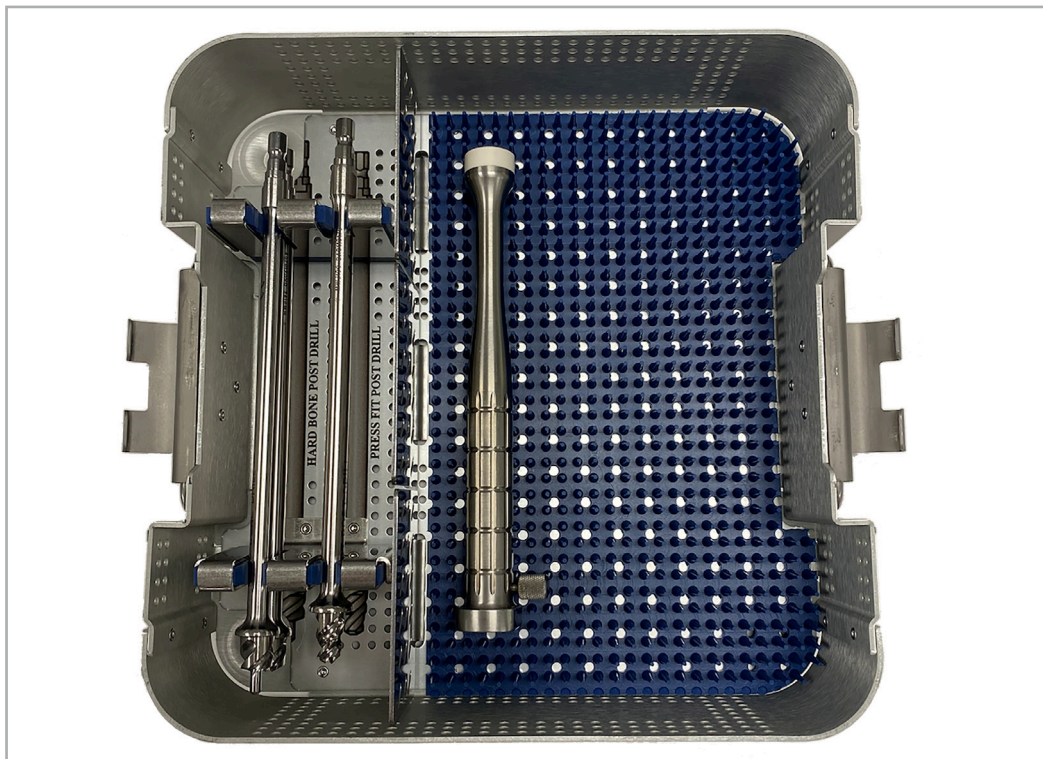

Tornier Perform Reversed Glenoid Glenosphere Trials Tray (Ref. YKAD262)

Reference	Description
MWJ132	Standard glenosphere trial, 36mm
MWJ133	Standard glenosphere trial, 39mm
MWJ134	Standard glenosphere trial, 42mm
MWJ135	Lateralized glenosphere trial (+3mm), 33mm
MWJ136	Lateralized glenosphere trial (+3mm), 36mm
MWJ137	Lateralized glenosphere trial (+3mm), 39mm
MWJ138	Lateralized glenosphere trial (+3mm), 42mm
MWJ139	Eccentric glenosphere trial (+2mm inferior offset), 36mm
MWJ140	Eccentric glenosphere trial (+3mm inferior offset), 39mm
MWJ141	Eccentric glenosphere trial (+4mm inferior offset), 42mm



Tornier Perform Reversed short post drill tray (Ref. YKAD266)

Reference	Description
MWJ190	Perform Reversed press-fit post drill, 7mm post
MWJ192	Perform Reversed baseplate post hard bone drill
MWJ193	Perform Reversed baseplate post hard bone drill non-cannulated
MWJ10462	Cannulated glenosphere inserter

Optional reamers

Reference	Description
MWJ166	Full moon baseplate reamer, 25mm
MWJ167	Full moon baseplate reamer, 29mm

Sterile items

Reference	Description
MWJ126	Peripheral screw drill bit, 3.2mm
DWD017	Sterile single use pin – 2.5mm X 220mm
EBO101	Cement restrictor
MWJ10461	Nitinol guide wire

Implants

Standard baseplates

Reference	Description
DWJ401	Standard baseplate, 25mm
DWJ411	Standard baseplate, 29mm



Lateralized augmented baseplates

Reference	Description
DWJ512	Lateralized baseplate (+3mm), 29mm
DWJ513	Lateralized baseplate (+6mm), 29mm
DWJ502	Lateralized baseplate (+3mm), 25mm
DWJ503	Lateralized baseplate (+6mm), 25mm



Press-fit posts

Reference	Description
DWJ002	Press-fit long post, 15mm
DWJ001	Press-fit short post, 7mm



Central screws (non-sterile)

Reference	Description
DWJ125	Central screw, 6.5mm x 25mm - non-sterile
DWJ130	Central screw, 6.5mm x 30mm - non-sterile
DWJ135	Central screw, 6.5mm x 35mm - non-sterile
DWJ140	Central screw, 6.5mm x 40mm - non-sterile
DWJ145*	Central screw, 6.5mm x 45mm - non-sterile*
DWJ150*	Central screw, 6.5mm x 50mm - non-sterile*
DWJ225	Central screw, 9.5mm x 25mm - non-sterile
DWJ230	Central screw, 9.5mm x 30mm - non-sterile
DWJ235	Central screw, 9.5mm x 35mm - non-sterile
DWJ240	Central screw, 9.5mm x 40mm - non-sterile
DWJ245*	Central screw, 9.5mm x 45mm - non-sterile*
DWJ250*	Central screw, 9.5mm x 50mm - non-sterile*

* special order only



Peripheral screws (non-sterile)

Reference	Description
DWJ314	Peripheral screw 5.0mm, 14mm - non-sterile
DWJ318	Peripheral screw 5.0mm, 18mm - non-sterile
DWJ322	Peripheral screw 5.0mm, 22mm - non-sterile
DWJ326	Peripheral screw 5.0mm, 26mm - non-sterile
DWJ330	Peripheral screw 5.0mm, 30mm - non-sterile
DWJ334	Peripheral screw 5.0mm, 34mm - non-sterile
DWJ338	Peripheral screw 5.0mm, 38mm - non-sterile
DWJ342	Peripheral screw 5.0mm, 42mm - non-sterile
DWJ346	Peripheral screw 5.0mm, 46mm - non-sterile
DWJ350	Peripheral screw 5.0mm, 50mm - non-sterile
DWJ354	Peripheral screw 5.0mm, 54mm - non-sterile



Glenospheres (CoCr)

Reference	Description
DWJ012	Standard glenosphere, 36mm
DWJ013	Standard glenosphere, 39mm
DWJ014	Standard glenosphere, 42mm
DWJ021	Lateralized glenosphere (+3mm), 33mm
DWJ022	Lateralized glenosphere (+3mm), 36mm
DWJ023	Lateralized glenosphere (+3mm), 39mm
DWJ024	Lateralized glenosphere (+3mm), 42mm
DWJ032	Eccentric glenosphere (+2mm inferior offset), 36mm
DWJ033	Eccentric glenosphere (+3mm inferior offset), 39mm
DWJ034	Eccentric glenosphere (+4mm inferior offset), 42mm
DWJ1017301	Cannulated standard glenosphere, 36mm
DWJ1017302	Cannulated standard glenosphere, 39mm
DWJ1017303	Cannulated standard glenosphere, 42mm
DWJ1017304	Cannulated lateralized glenosphere (+3mm), 33mm
DWJ1017305	Cannulated lateralized glenosphere (+3mm), 36mm
DWJ1017306	Cannulated lateralized glenosphere (+3mm), 39mm
DWJ1017307	Cannulated lateralized glenosphere (+3mm), 42mm
DWJ1017701	Cannulated eccentric glenosphere (+2mm inferior offset), 36mm
DWJ1017702	Cannulated eccentric glenosphere (+3mm inferior offset), 39mm
DWJ1017703	Cannulated eccentric glenosphere (+4mm inferior offset), 42mm

Glenospheres (Ti)

Reference	Description
DWJ1017201	Cannulated Ti standard glenosphere, 36mm
DWJ1017202	Cannulated Ti standard glenosphere, 39mm
DWJ1017203	Cannulated Ti standard glenosphere, 42mm
DWJ1017205	Cannulated Ti lateralized glenosphere (+3mm), 36mm
DWJ1017601	Cannulated Ti eccentric glenosphere (+2mm inferior offset), 36mm

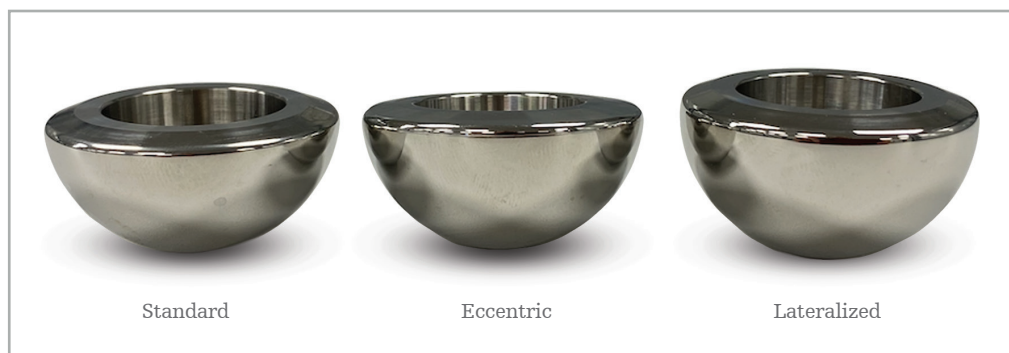

This document is intended solely for the use of healthcare professionals. A surgeon must always rely on his or her own professional clinical judgment when deciding whether to use a particular product when treating a particular patient. Stryker does not dispense medical advice and recommends that surgeons be trained in the use of any particular product before using it in surgery.

The information presented is intended to demonstrate a Stryker product. A surgeon must always refer to the package insert, product label and/or instructions for use, including the instructions for cleaning and sterilization (if applicable), before using any Stryker product. Products may not be available in all markets because product availability is subject to the regulatory and/or medical practices in individual markets. Please contact your Stryker representative if you have questions about the availability of Stryker products in your area.

The instructions for use, operative techniques, cleaning instructions, patient information leaflets and other associated labeling may be requested online at ifu.stryker.com or wright.com. If saving the instructions for use, operative techniques, cleaning instructions from the above mentioned websites, please make sure you always have the most up to date version prior to use.

Stryker Corporation or its divisions or other corporate affiliated entities own, use or have applied for the following trademarks or service marks: Adaptis, Aequalis, BIO-RSA, Perform, Stryker, Tornier. All other trademarks are trademarks of their respective owners or holders.

Content ID: AP-010185F 25-Aug-2023

Copyright © 2023 Stryker

Manufacturer:

Tornier, Inc.
10801 Nesbitt Avenue South
Bloomington, MN 55437
t: 888 867 6437
t: 952 426 7600

stryker.com